

O-RINGS & GASKETS

CHRYSLER

TECHNICAL INFORMATION

Chrysler Coated Metal Gaskets For Drier/Condenser Block Connections

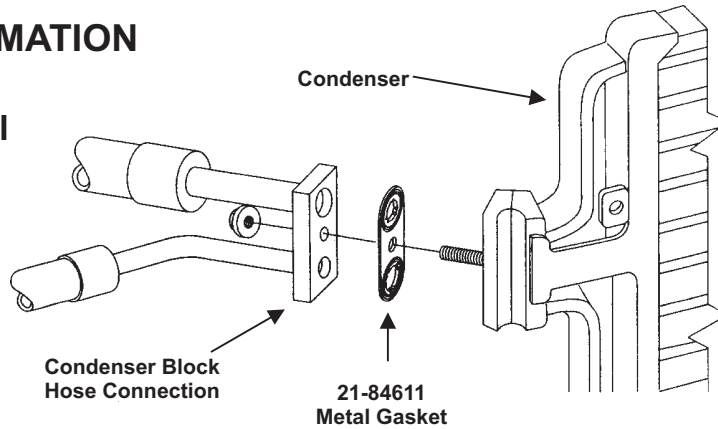

Chrysler Coated Metal Gaskets For A590 & C171 Compressor

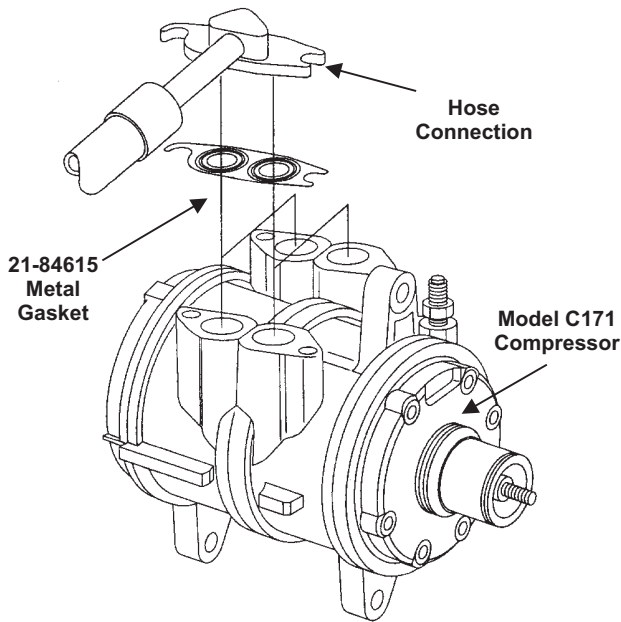

Chrysler Coated Metal Gaskets For Sanden Compressor

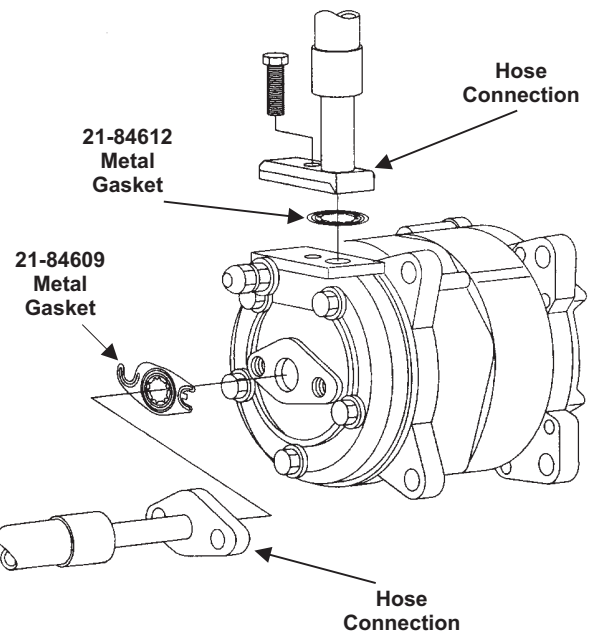

Chrysler Coated Metal Gaskets For RV2 Type Compressor

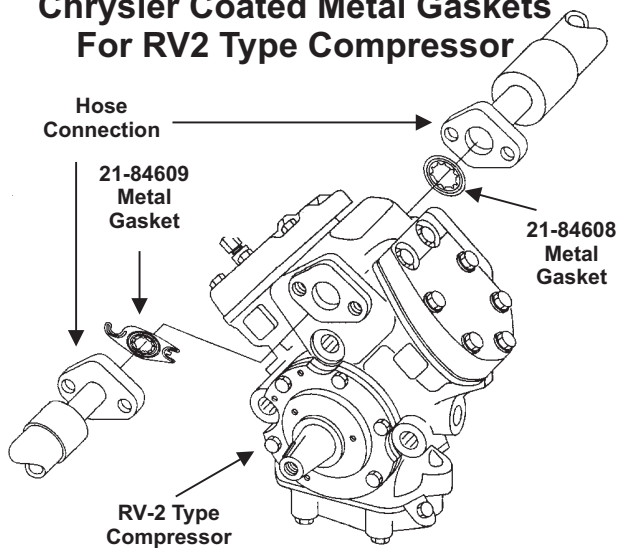

Chrysler Coated Metal Gaskets For 6C17 Variable Displacement Type Hose Connections

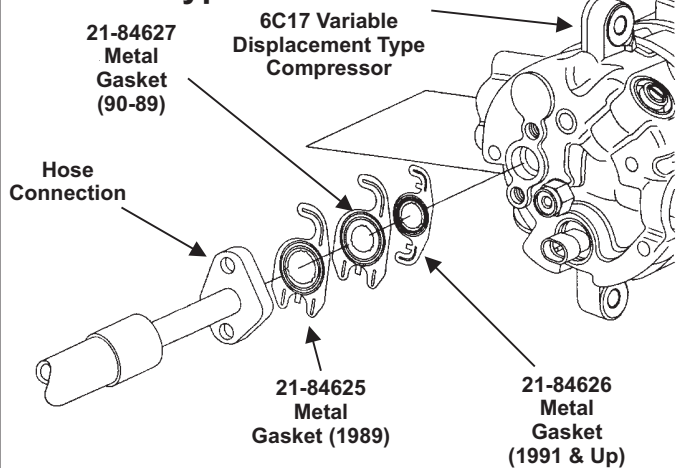

O-RINGS & GASKETS

CHRYSLER



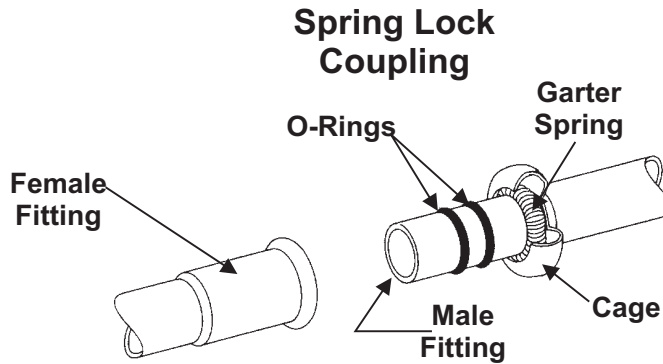





TECHNICAL INFORMATION



Always replace both O-Rings and garter springs when disconnecting springlock connection.











SPRINGLOCK COUPLING DISCONNECTION









Kits

 40-03501 #6 Springlock	 40-03502 #8 Springlock	 40-03503 #10 Springlock	 40-03504 #12 Springlock
 21-84727 #6 Garter Spring	 21-84728 #8 Garter Spring	 21-84729 #10 Garter Spring	 21-84730 #12 Garter Spring

21-24654
STANDARD SPRINGLOCK
ASSORTMENT KIT

21-24658
CHRYSLER SERVICE ASSORTMENT KIT
R-12 Only

 21-26002 Chrysler RV2 Suction	 21-26079	 21-26003 Chrysler RV2 Discharge Service Valve Gasket
 40-02509 Capillary	 40-02502 #6 Hose	 40-02507
 40-02503 #8 Hose	 40-02504 #10 Hose	 40-02531 Expansion Valve
 40-02528 Chrysler Exp.	 40-02536 Chrysler	

 21-84608 Chrysler RV2 Suction Gasket (5 each)	 21-84613 Chrysler Expansion Valve / Evaporator Gasket	 21-84608 Chrysler RV2 Suction Gasket (5 each)
 21-84609 Chrysler RV2 / Sanden Discharge Gasket	 21-84611 Chrysler Condenser Discharge Line Gasket	
 21-84614 Chrysler Rec. Drier Gasket	 21-84610 Chrysler H Type Suction / Liquid Gasket	 21-84615 Chrysler C171 / A590 Service Valve Gasket
		 21-84612 Chrysler / Sanden Suction Flange Gasket



















21-24698
CHRYSLER METAL GASKET
ASSORTMENT KIT













O-RINGS & GASKETS

CHRYSLER

Kits









21-24699
CHRYSLER/JEEP METAL
GASKET ASSORTMENT KIT

 21-84713 C171 / A590 Comp. Gasket Guide	 21-84709 Small Liquid Pilot For Block Valve	 21-84710 Large Suction Pilot For Block Valve	 40-02528-B Liquid O-Ring For Early Block Valves	 40-02531-B Suction O-Ring For Early Block Valves	 21-84625 6C17 Compressor Suc./ Dis. Gasket 5/8" I.D.
 21-84627 6C17 Compressor Suc./ Dis. Gasket 1/2" I.D.	 21-84649 RV2 Compressor Suction Port Gasket	 21-84643 Bottle Block Receiver Drier Gasket	 21-84612 Sanden Compressor Suction Gasket	 21-84614 Receiver Drier Block Gasket	 21-84609 RV2 / Sanden Discharge Gasket
 21-84636 Block Expansion Valve Evaporator Side Foam Coated Gasket - Black & Gold Color Coded	 21-84626 6C17 Compressor Suc./ Dis. Gasket	 21-84610 Block Expansion Valve Hose Side Gasket	 21-84611 Condenser Block Gasket	 21-84615 C171 / A590 Comp. Service Valve Gasket	 21-84613 Block Expansion Valve Evaporator Side Reg. Coated Gasket, Gold Color Coded

 40-03501 #6 O'Ring Green	 40-03502 #8 O'Ring Green	 40-03503 #10 O'Ring Green	 40-03504 #12 O'Ring Green
 21-84727 #6 Garter Spring	 21-84728 #8 Garter Spring	 21-84729 #10 Garter Spring	 21-84730 #12 Garter Spring
 40-02675 G #6 Metric O'ring	 40-02673 G #8 Metric O'ring	 40-02658 G #10 Metric O'ring	 40-02661 G #12 Metric O'ring

21-24740 G
DELUXE SPRINGLOCK
ASSORTMENT KIT

21-24743 G
STANDARD & METRIC SPRINGLOCK
ASSORTMENT KIT

 40-03501 #6 O'Ring Green	 40-03502 #8 O'Ring Green	 40-03503 #10 O'Ring Green	 40-03504 #12 O'Ring Green
 40-02675 G #6 Metric O'ring	 40-02673 G #8 Metric O'ring	 40-02658 G #10 Metric O'ring	 40-02661 G #12 Metric O'ring

O-RINGS & GASKETS

CHRYSLER

Fiber Gaskets

21-26002



Chry. RV2 Suction Service Valve Gasket

21-26003



Chry. RV2 Discharge Service Valve Gasket

21-26011



Chry. RV2 Head Gasket

21-26012



Chry. RV2 Valve Plate Gasket

21-26013

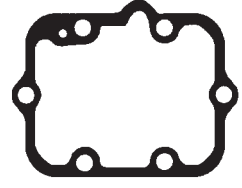

Chry. RV2 Base Gasket

Lathe Cut Seals (actual size)

21-26057

Chry. Comp. C171 Shell / A590 Shell (front & back) Seal

21-26051

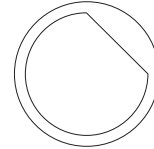

YORK TEFLON ROTOLOCK SEAL

21-26095



Chrysler Gasket 6C17

21-26098



Chrysler 6CA17K Rear Head

21-26079



Chry. RV2 Service Valve Seal













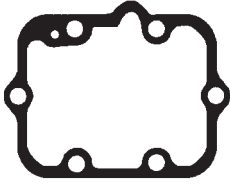

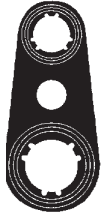
21-26058

Chry. Comp. A590 Center Shell Seal

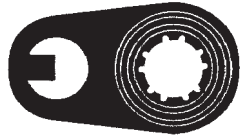

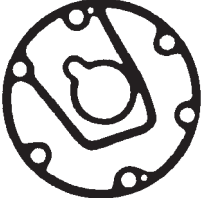



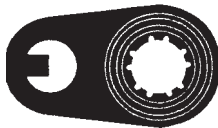

O-RINGS & GASKETS

CHRYSLER

Metal Gaskets

<p>21-84605</p>  <p>Chry. RV2 Head Gasket</p>	<p>21-84606</p>  <p>Chry. RV2 Valve Plate Gasket</p>	<p>21-84607</p>  <p>Chry. RV2 Base Gasket</p>	<p>21-84608</p>  <p>Chry. RV2 Suction Port Gasket</p>	<p>21-84609</p>  <p>Chry. RV2 / Sanden Discharge Port Gasket</p>
<p>21-84610</p>  <p>Chry. Block Exp. Valve Gasket</p>	<p>21-84611</p>  <p>Chry. Condenser Block Gasket</p>	<p>21-84612</p>  <p>Chry. Sanden Suction Port Gasket</p>	<p>21-84613</p>  <p>Chry. Block Exp. Valve Gasket (regular type)</p>	<p>21-84614</p>  <p>Chry. Receiver Drier Gasket</p>
<p>21-84615</p>  <p>Chry. C171 / A590 Comp. Service Port</p>	<p>21-84616</p>  <p>Chry. C171 / A590 Comp. Cylinder Head Gasket</p>	<p>21-84625</p>  <p>Chry. 6C17 Comp. Service Flange Gasket</p>	<p>21-84626</p>  <p>Chry. 6C17 Comp. Service Gasket</p>	<p>21-84627</p>  <p>Chry. 6C17 Comp. Service Gasket</p>
<p>21-84636</p>  <p>Chry. Block Exp. Valve (Black)</p>	<p>21-84643</p>  <p>Chry. Receiver Drier Gasket</p>			

Miscellaneous Items













<p>21-84709</p>  <p>Small Liquid Pilot For Block Valve</p>	<p>21-84710</p>  <p>Large Suction Pilot For Block Valve</p>	<p>21-84713</p>  <p>C171 / A590 Comp. Gasket Guide</p>	<p>21-84727</p>  <p>#6 Springlock Garter</p>	<p>21-84728</p>  <p>#8 Springlock Garter</p>
<p>21-84729</p>  <p>#10 Springlock Garter</p>	<p>21-84730</p>  <p>#12 Springlock Garter</p>	<p>21-84841</p>  <p>DODGE SANDEN SUCTION PORT</p>	<p>21-84842</p>  <p>DODGE SANDEN DISCHARGE PORT</p>	

O-RINGS & GASKETS

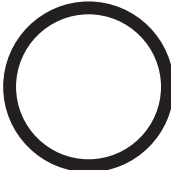
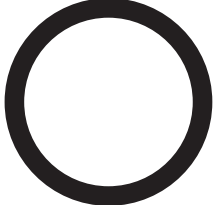
CHRYSLER

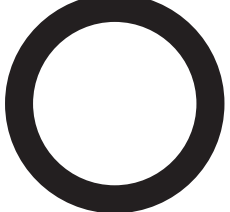
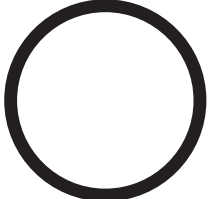
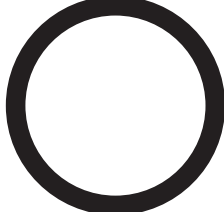
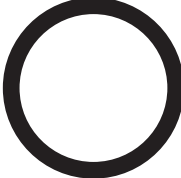
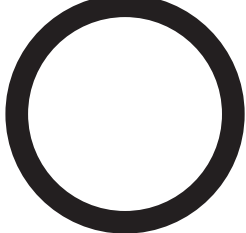
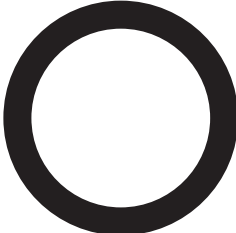
O-RINGS (actual size)

* Indicates Green HNBR

<p>40-03501 *</p>  <p>STANDARD</p> <p>40-02502 #6 HOSE FITTING</p>	<p>40-03502 *</p>  <p>STANDARD</p> <p>40-02503 #8 HOSE FITTING</p>	<p>40-03503 *</p>  <p>STANDARD</p> <p>40-02504 #10 HOSE FITTING</p>	<p>40-03504 *</p>  <p>STANDARD</p> <p>40-02507 #12 HOSE FITTING</p>	<p>40-02509</p>  <p>Capillary Tube O'Ring</p>	<p>40-02514</p>  <p>Chry. 6C17 Large Control Valve / Oil Plug / Pressure Relief Valve</p>
<p>40-02516</p>  <p>Chry. Comp 6C17 Small Control Valve Port Seal</p>	<p>40-02517</p>  <p>Chry. Comp. 6C17 Large Control Valve Port Seal</p>	<p>40-02525</p>  <p>Chry. Comp. 6C17 Switch Port Seal</p>	<p>40-02528</p>  <p>Chry. Block Exp. Valve Seal</p>	<p>40-02531</p>  <p>Chry. Block Exp. Valve Seal</p>	
<p>40-02535</p>  <p>Chry. RV2 EPR & ETR Valve Seal</p>	<p>40-02536</p>  <p>Chry. Comp. RV2 Discharge Muffler Seal</p>	<p>40-02537</p>  <p>Chry. Comp. C171 & A590 Service Valve Seal</p>	<p>40-02538</p>  <p>Shaft Seal O'Ring C171</p>		
<p>40-02539</p>  <p>Shaft Seal O-Ring C171</p>	<p>40-02557</p>  <p>Chry. 6C17 Large Control Valve Outer Seal</p>	<p>40-02637</p>  <p>Chry. Comp. RV2 Oil Pump Seal</p>	<p>40-02646</p>  <p>Chry. Comp. RV2 Shaft Seal O-Ring</p>		
<p>40-02540</p> <p>SEE NEXT PAGE FOR DRAWING OF O-RING</p> <p>C171 Shell O-Ring</p>					

O-RINGS & GASKETS

CHRYSLER

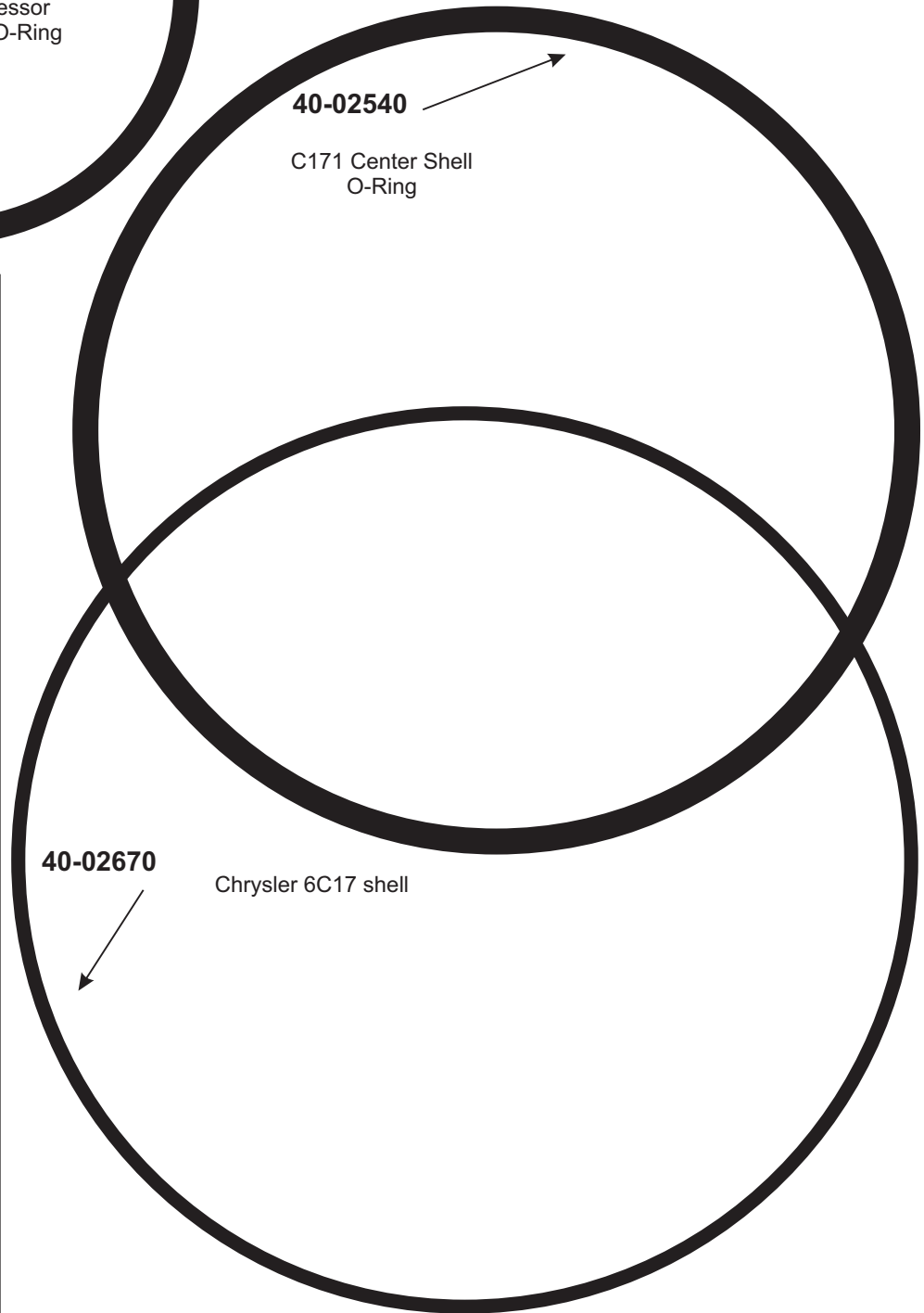
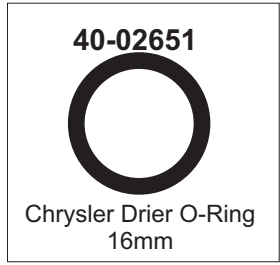

<p>40-02658 G</p> <p>#10 Metric Springlock O-ring</p>
<p>40-02661 G</p> <p>#12 Metric Springlock O-Ring</p>
<p>40-02673 G</p> <p>#8 Metric Springlock O-Ring</p>
<p>40-02675 G</p> <p>#6 Metric Springlock O-Ring</p>

O-RINGS & GASKETS

CHRYSLER

Assortment Kits

21-24654	Standard Springlock Assortment Kit
21-24658	Chrysler Service Assortment Kit
21-24740 G	Deluxe Springlock Assortment Kit
21-24743	Standard & Metric Springlock O'Ring Assortment Kit
21-24698	Chrysler Metal Gasket Assortment Kit
21-24699	Chrysler / Jeep Metal Gasket Assortment Kit

Fiber Gaskets

21-26002	Chrysler RV2 Suction Service Valve Gasket
21-26003	Chrysler RV2 Discharge Service Valve Gasket
21-26011	Chrysler RV2 Head Gasket
21-26012	Chrysler RV2 Valve Plate Gasket
21-26013	Chrysler RV2 Base Gasket

Black R12 (only)	Black R12 /R134a	Blue R12 /R134a	Green R12 /R134a	Yellow R12 /R134a
-----------------------------	-----------------------------	----------------------------	-----------------------------	------------------------------

Lathe Cut Seals

21-26057	21-26057 N	21-26057 B	Chrysler Compressor C171 Shell / A590 Shell (front & back)
21-26058	21-26058 N	21-26058 B	Chrysler Compressor A590 Center Shell Seal
21-26079		21-26079 B	Chrysler RV-2 Service Valve Seal

Metal Gaskets

21-84605	Chrysler RV2 Head Gasket OE 3664519
21-84606	Chrysler RV2 Valve Plate Gasket OE 3664550
21-84607	Chrysler RV2 Base Gasket OE 3703672
21-84608	Chrysler RV2 Suction Port Gasket OE 3846567
21-84609	Chrysler RV2 / Sanden Discharge Port Gasket OE 3846272
21-84610	Chrysler Block Expansion Valve Suction, Liquid Line Gasket
21-84611	Chrysler Condenser Block Gasket OE 3848635
21-84612	Chrysler Sanden Suction Port Gasket OE 5210223
21-84613	Chrysler Block (Regular Type) Expansion Valve Gasket OE 3846836
21-84614	Chrysler Receiver Drier Block Gasket OE 3847083
21-84615	Chrysler C171 / A590 Compressor Service Port Gasket
21-84616	Chrysler C171 / A590 Compressor Cylinder Head Gasket
21-84625	Chrysler 6C17 Compressor Service Flange OE 3849730 (5/8" ID)
21-84626	Chrysler 6C17 Compressor Service Flange OE 4638189 (1991 - up)
21-84627	Chrysler 6C17 Compressor Service Flange OE 5264373 (1/2" ID)
21-84636	Chrysler Black Block Expansion Valve w/ Foam Coating OE 4677045
21-84643	Chrysler Receiver Drier Block Gasket OE 4720747 (3.77" pilot)
21-84649	RV2 Compressor Suction Port Gasket

Black R12 (only)	Black R12 /R134a	Blue R12 /R134a	Green R12 /R134a	Yellow R12 /R134a
-----------------------------	-----------------------------	----------------------------	-----------------------------	------------------------------

O-Rings

40-02502	40-02502 N	40-02502 B	40-03501 G	40-02502 Y	#6 Hose Fitting O-Ring
40-02503	40-02503 N	40-02503 B	40-03502 G	40-02503 Y	#8 Hose Fitting O-Ring
40-02504	40-02504 N	40-02504 B	40-03503 G	40-02504 Y	#10 Hose Fitting O-Ring
40-02507	40-02507 N	40-02507 B	40-03504 G	40-02507 Y	#12 Hose Fitting O-Ring
40-02509	40-02509 N	40-02509 B	40-02509 G		Capillary Tube O-Ring
40-02514	40-02514 N	40-02514 B	40-05214 G	40-02514 Y	Chrysler 6C17 Large Control Valve (inner) O-Ring / Oil Plug
40-02516	40-02516 N	40-02516 B	40-02516 G		Chry. Comp. 6C17 Small Control Valve Port O-Ring (Outer)
40-02517	40-02517 N	40-02517 B	40-02517 G		Chrysler Comp. 6C17 Large Control Valve Port O-Ring
40-02525	40-02525 N	40-02525 B	40-02525 G		Chrysler Comp. 6C17 Switch Port O-Ring
40-02528	40-02528 N	40-02528 B			Chrysler Block Expansion Valve Liquid Line O-Ring
40-02531	40-02531 N	40-02531 B	40-02531 G		Chrysler Block Expansion Valve Suction Line O-Ring
40-02535	40-02535 N	40-02535 B			Chrysler RV2 EPR & ETR Valve O-Ring
40-02536	40-02536 N	40-02536 B			Chrysler Comp. RV2 Discharge Muffler O-Ring
40-02537	40-02537 N	40-02537 B	40-02537 G		Chrysler Comp. C171 & A590 Service Valve O-Ring
40-02540	40-02540 N	40-02540 B			Chrysler Center Shell O-Ring C171
40-02557	40-02557 N	40-02557 B	40-02557 G		Chrysler 6C17 Large Control Valve Outer O-Ring
40-02637	40-02637 N	40-02637 B			Chrysler Compressor RV2 Oil Pump O-Ring
40-02646	40-02646 N	40-02646 B			Chrysler Compressor RV2 Shaft Seal O-Ring
40-02647	40-02647 N	40-02647 B			Chrysler Compressor RV2 Nose Plate O-Ring
	40-02651 N	40-02651 B			Chrysler / Jeep Drier O-Ring 16mm ID OE# 04746781
			40-02658 G		#10 Metric Springlock O'Ring
			40-02661 G		#12 Metric Springlock O'Ring
40-02670	40-02670 N	40-02670 B			Chrysler 6C17 Shell O-Ring
			40-02673 G		#8 Metric Springlock O'Ring
			40-02675 G		#6 Metric Springlock O'Ring

Miscellaneous Items

21-84709	Small Liquid Pilot For Block Valve
21-84710	Large Suction Pilot For Block Valve
21-84713	C171 / A590 Compressor Gasket Guide
21-84727	#6 Garter Spring
21-84728	#8 Garter Spring
21-84729	#10 Garter Spring
21-84730	#12 Garter Spring

O-RINGS & GASKETS

FORD

Ford Special Compressor Green Or Red O-Rings

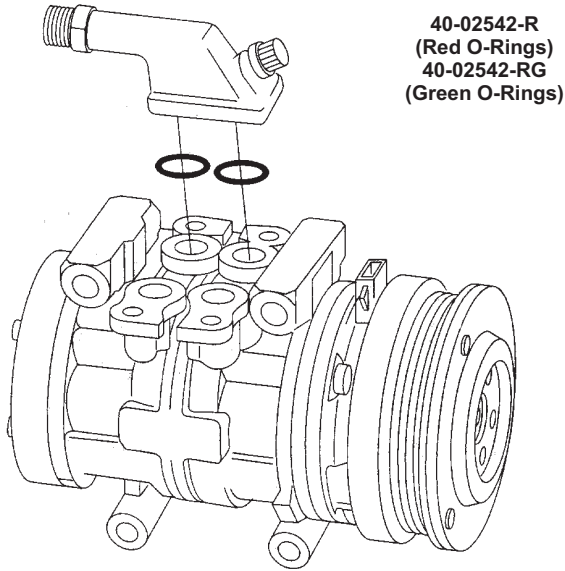

Ford, Special Compressor
O-Rings with Oval Cross Section

Ford Nippondenso 10PA Series Compressor

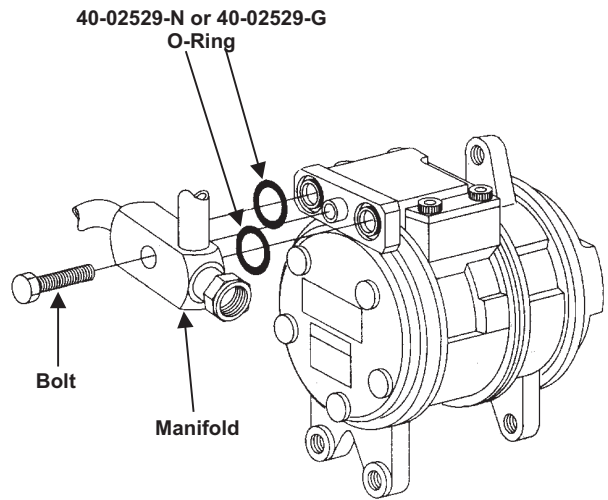

Ford Spring Lock Coupling

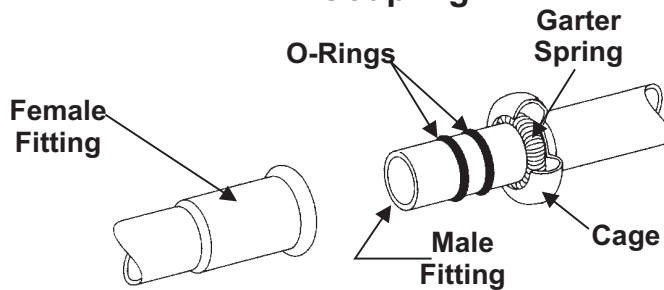

Always replace both O-Rings
and garter springs when
disconnecting springlock
connection.

SPRINGLOCK COUPLING DISCONNECTION

Ford Aerostar Heater Core Springlock Hose Fitting

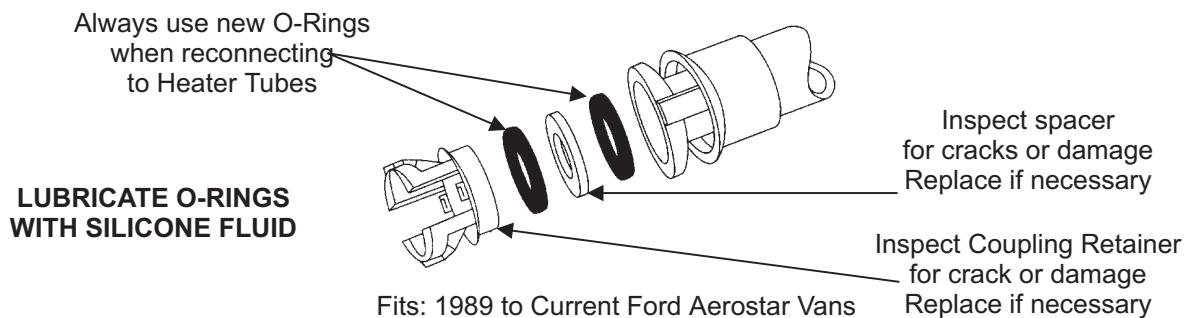

LUBRICATE O-RINGS
WITH SILICONE FLUID

Fits: 1989 to Current Ford Aerostar Vans

O-RINGS & GASKETS

FORD

Kits

**21-24654
STANDARD SPRINGLOCK
ASSORTMENT KIT**

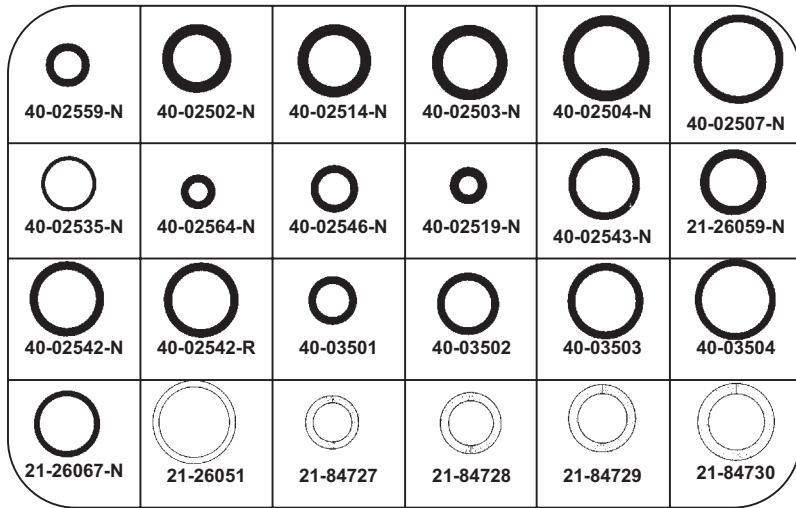
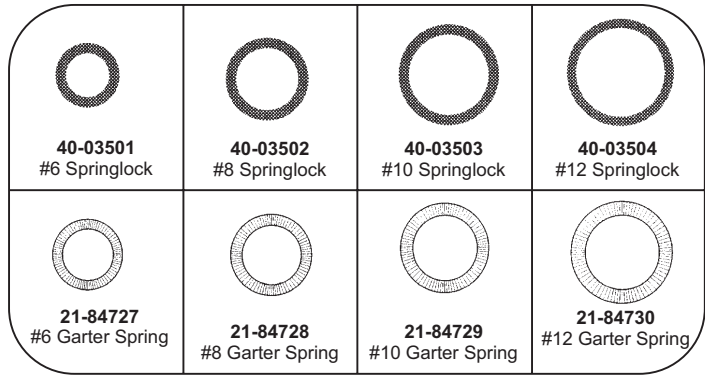

**21-24656
FORD SERVICE
ASSORTMENT KIT**

**21-24700
FORD SERVICE
ASSORTMENT KIT**

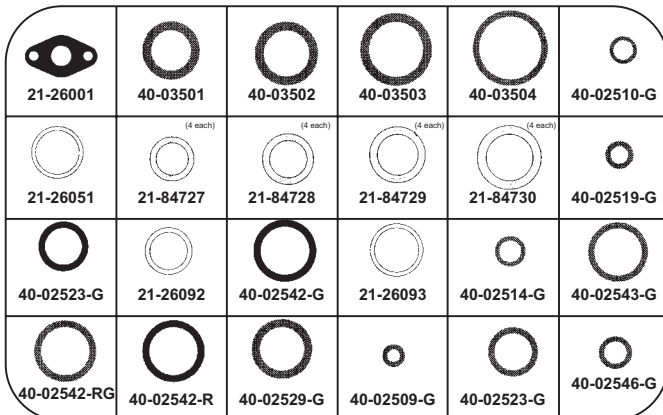
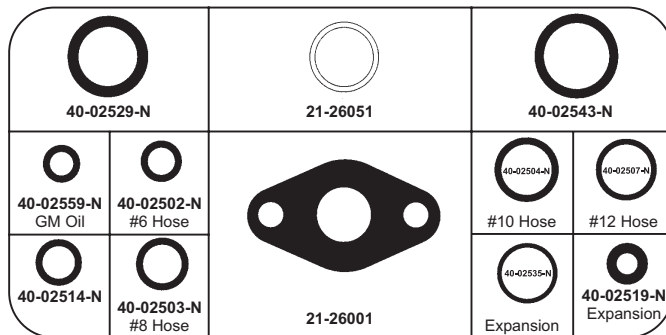













**21-24701
FORD MASTER SHOP O-RING /
GASKET ASSORTMENT KIT**

O-RINGS & GASKETS

FORD

Kits





21-24740 G DELUXE SPRINGLOCK ASSORTMENT KIT









 40-03501 #6 O'Ring Green	 40-03502 #8 O'Ring Green	 40-03503 #10 O'Ring Green	 40-03504 #12 O'Ring Green
 21-84727 #6 Garter Spring	 21-84728 #8 Garter Spring	 21-84729 #10 Garter Spring	 21-84730 #12 Garter Spring
 40-03675 G #6 Metric O'ring	 40-02673 G #8 Metric O'ring	 40-02658 G #10 Metric O'ring	 40-02661 G #12 Metric O'ring

40-02602 G Metric Cycling Switch O-Ring OEM #N807083-S (Green HNBR)	40-02510 G Compressor Oil Plug / Switch O-Ring (Green HNBR)	40-03501 NO. 6 Standard Hose Fitting / Springlock, Drier O-Ring (Green HNBR)	40-02675 G NO. 6 Metric Hose Fitting / Springlock O-Ring OEM #391396-S100 (Green HNBR)	40-02514 G Standard Cycling Switch O-Ring (Green HNBR)	40-03502 NO. 8 Standard Hose Fitting / Springlock O-Ring OEM #391303-S100 (Green HNBR)
40-02673 NO. 8 Metric Hose Springlock O-Ring OEM #391397-S100 (Green HNBR)	40-02658 G NO. 10 Metric Hose Springlock O-Ring OEM #391304-S100 (Green HNBR)	40-03603 NO. 10 Standard Hose Fitting / Springlock, Drier O-Ring OEM #391306-S100 (Green HNBR)	40-02661 G NO. 12 Metric Hose Springlock O-Ring OEM #391305-S100 (Green HNBR)	40-03504 NO. 12 Standard Hose Fitting / Springlock O-Ring OEM #391307-S100 (Green HNBR)	40-02542 G Nippondenso / FS6 Manifold O-Ring - Round Cross Section (Green HNBR)
40-02542 RG Nippondenso / FS6 Manifold O-Ring - Oval Cross Section OEM #N390697 (Green HNBR)	40-02542 R Nippondenso / FS6 Manifold O-Ring - Red Oval Cross Section OEM #N390697R (Red Neoprene)	40-02529 G Nippondenso 10PA / FS10 / FX15 Manifold O-Ring - Round Cross Section OEM #N806959-S (Green HNBR)	40-02546 G Orifice Tube O-Ring (Green HNBR)	40-02531 G Nippondenso / Ford Manifold O-Ring OEM #N801189-S (Green HNBR)	40-02523 Heater Core Springlock Small O-Ring (Black Buna) 40-02542 Heater Core Springlock Large O-Ring (Black Buna)
21-26092 Teflon Heater Core Springlock Spacer - Small	21-26091 Teflon Heater Core Springlock Spacer - Large	21-84727 No. 6 Springlock Garter Spring (10 per)	21-84728 No. 8 Springlock Garter Spring (10 per)	21-84729 No. 10 Springlock Garter Spring (10 per)	21-84730 No. 12 Springlock Garter Spring (10 per)

27-24741 G FORD R-12 / R134A SERVICE O'RING KIT

27-24742 G FORD SPRINGLOCK STANDARD O-RING ASSORTMENT

 40-03501 No. 6 Springlock O-Ring (HNBR Green)	 40-03502 No. 8 Springlock O-Ring (HNBR Green)
 40-03503 No. 10 Springlock O-Ring (HNBR Green)	 40-03504 No. 12 Springlock O-Ring (HNBR Green)

 40-03501 #6 O'Ring Green	 40-03502 #8 O'Ring Green	 40-03503 #10 O'Ring Green	 40-03504 #12 O'Ring Green
 40-02675 G #6 Metric O'ring	 40-02673 G #8 Metric O'ring	 40-02658 G #10 Metric O'ring	 40-02661 G #12 Metric O'ring



21-24743 G STANDARD & METRIC SPRINGLOCK ASSORTMENT KIT

O-RINGS & GASKETS

FORD

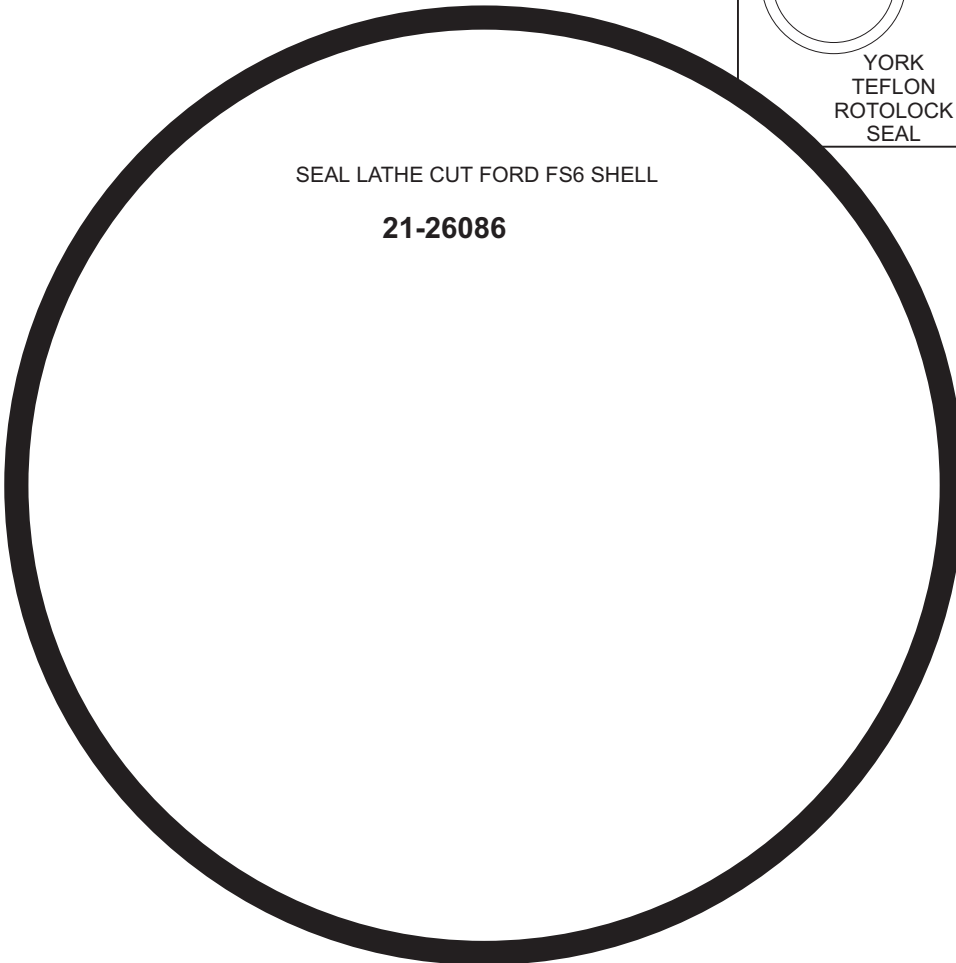

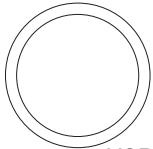

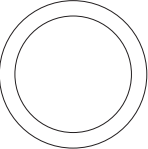
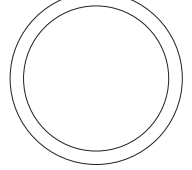
Lathe Cut Seals (Actual Size)



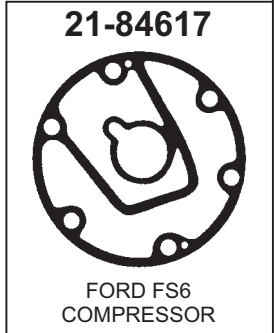

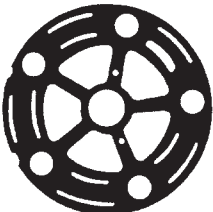

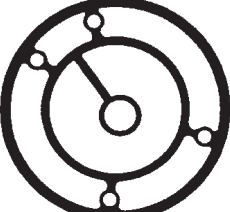
<p>21-26051</p>  <p>YORK TEALON ROTOLOCK SEAL</p>	<p>21-26059</p>  <p>YORK TUBE-O SEAL</p>	<p>21-26067</p>  <p>YORK SERVICE VALVE SEAL</p>
<p>21-26092</p>  <p>SEAL, TEALON HEATER CORE SPRINGLOCK</p>	<p>21-26093</p>  <p>SEAL, TEALON HEATER CORE SPRINGLOCK</p>	

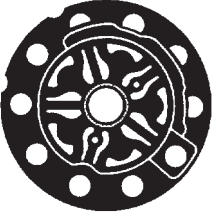
Metal Gaskets



<p>21-84623</p>  <p>FORD FX15 OE# F1VH-190970-AA</p>	<p>21-84628</p>  <p>FORD FX15 OE# E95H-19D970AA</p>	<p>21-84629</p>  <p>FORD FX15 OE# F1VH-19D970-BA</p>	<p>21-84642</p>  <p>FORD FX15 / FS10 OE# F4LH-19D970AA</p>	<p>21-84644</p>  <p>FORD FS10 OE# F3VH-19D970-AB</p>
--	---	--	---	--











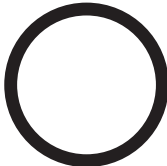

Miscellaneous Items

<p>21-84727</p>  <p>#6 Springlock Garter</p>	<p>21-84728</p>  <p>#8 Springlock Garter</p>	<p>21-84729</p>  <p>#10 Springlock Garter</p>	<p>21-84730</p>  <p>#12 Springlock Garter</p>	
--	--	---	---	--

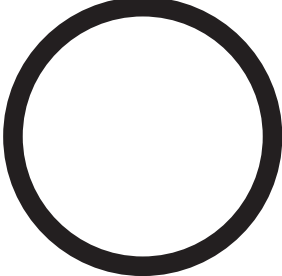
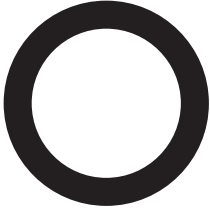
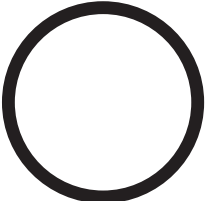
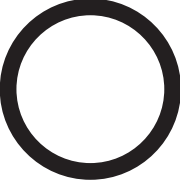
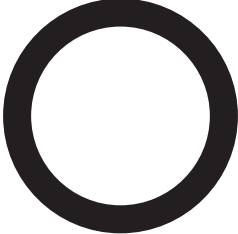
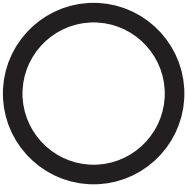
O-RINGS & GASKETS

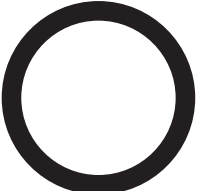
FORD

O-RINGS (Actual Size)

<p>40-03501</p>  <p>40-02502 #6 HOSE FITTING</p>	<p>40-03502</p>  <p>40-02503 #8 HOSE FITTING</p>	<p>40-03503</p>  <p>40-02504 #10 HOSE FITTING</p>	<p>40-03504</p>  <p>40-02507 #12 HOSE FITTING</p>	<p>40-02510</p>  <p>OIL TUBE SEAL</p>
<p>40-02514</p>  <p>OIL PLUG O-RING</p>	<p>40-02523</p>  <p>FORD AEROSTAR HEATER CORE SPRINGLOCK SMALL TUBE</p>	<p>40-02527</p>  <p>FORD HR980 SHAFT SEAL O-RING</p>	<p>40-02529</p>  <p>FORD COMP. FX-15/FS10 SERVICE VALVE O-RING OE# N805340-S</p>	<p>40-02535</p>  <p>FORD EXP. VALVE O-RING</p>
<p>40-02537</p>  <p>FORD COMP. FS6 SERVICE VALVE O-RING</p>	<p>40-02539</p>  <p>FORD COMP. FS6 SHAFT SEAL O-RING</p>	<p>40-02542</p>  <p>FORD AEROSTAR HEATER CORE SPRINGLOCK O-RING LARGE FORD FS6 COMP. SUC./ DIS O-RING</p>	<p>40-02542R</p>  <p>OVAL TYPE FORD FS6 SERVICE VALVE O-RING</p>	<p>40-02543</p>  <p>FORD BLOCK EXPANSION VALVE O-RING</p>
<p>40-02545</p> <p>SEE NEXT PAGE FOR DRAWING</p> <p>FORD FS6 CYLINDER HEAD O-RING</p>	<p>40-02546</p>  <p>FORD ORIFICE TUBE O-RING</p>	<p>40-02552</p> <p>SEE NEXT PAGE FOR DRAWING</p> <p>FORD COMPRESSOR SHELL CASE O-RING</p>	<p>40-02556</p>  <p>FORD BLOCK EXPANSION VALVE O-RING</p>	<p>40-02559</p>  <p>FORD METRIC O-RING</p>

O-RINGS & GASKETS

FORD

O-RINGS (actual Size)

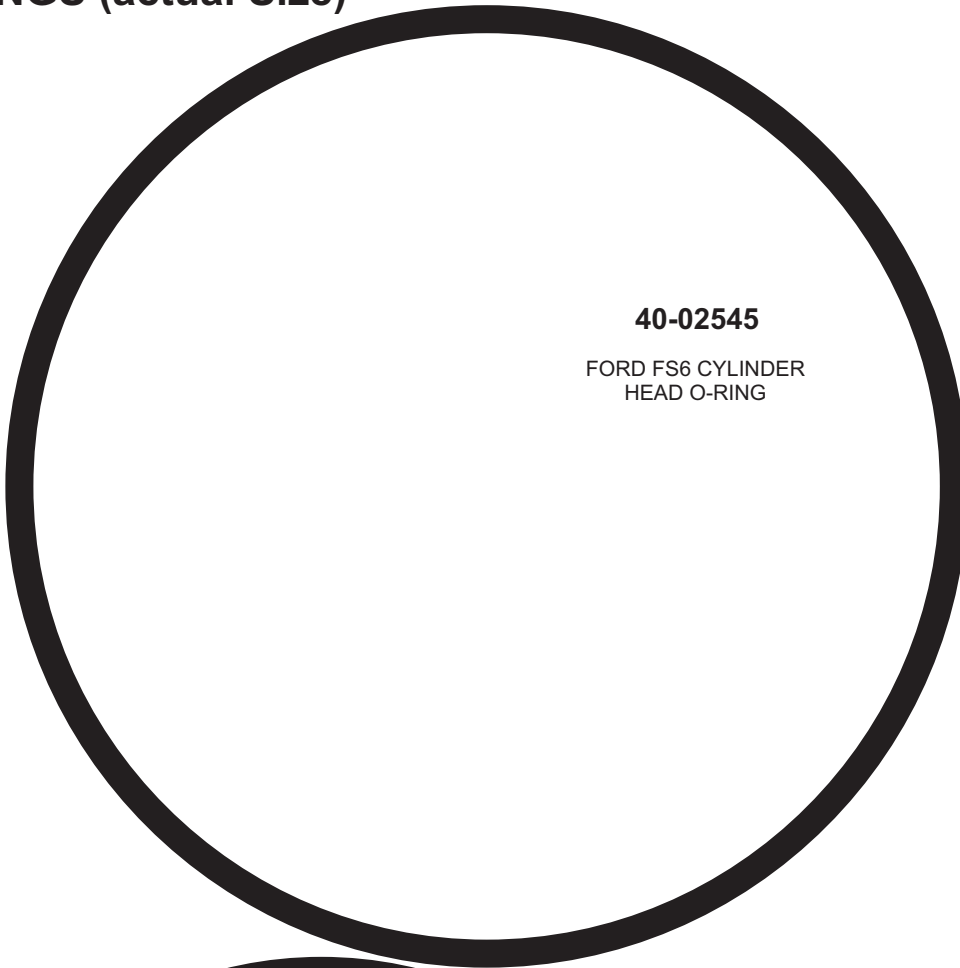

40-02545

FORD FS6 CYLINDER
HEAD O-RING

40-02602



FORD R134A PRESSURE
CYCLING SWITCH O-RING
OE# N807083

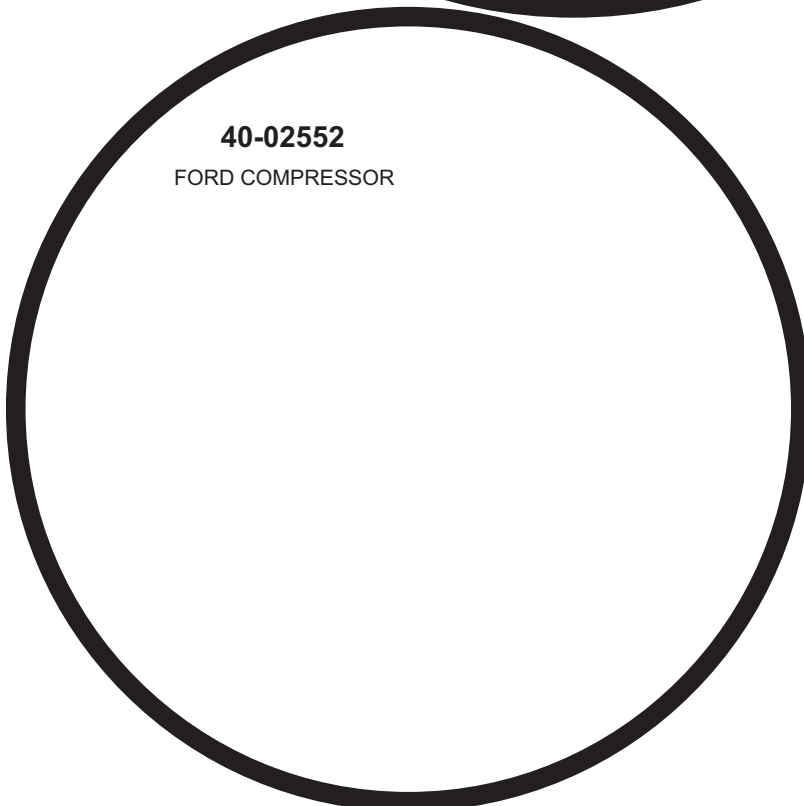

40-02552

FORD COMPRESSOR

40-02658G



FORD #10 METRIC

40-02661G



FORD #12 METRIC O-
RING

40-02673-G



FORD #8 METRIC
FITTING O-RING
OE# 391397-S100

40-02675-G



FORD #6 METRIC
FITTING O-RING

O-RINGS & GASKETS

FORD

Assortment Kits

21-24654	STANDARD SPRINGLOCK ASSORTMENT KIT
21-24656	FORD SERVICE ASSORTMENT KIT
21-24700	FORD SERVICE ASSORTMENT KIT
21-24701	FORD MASTER SHOP O-RING / GASKET ASSORTMENT KIT
21-24740 G	DELUXE SPRINGLOCK ASSORTMENT KIT
21-24741 G	FORD R-12 / R134A SERVICE O-RING ASSORTMENT KIT
21-24742 G	FORD SPRINGLOCK STANDARD O-RING ASSORTMENT KIT
21-24743 G	FORD STANDARD & METRIC SPRINGLOCK O-RING ASSORTMENT KIT

Black R12 (only)	Black R12 /R134a	Blue R12 /R134a	Green R12 /R134a	Yellow R12 /R134a
----------------------------	----------------------------	---------------------------	----------------------------	-----------------------------

Lathe Cut Seals

21-26051 (TEFLON)					YORK TEFLON ROTOLOCK SEAL
21-26059	21-26059 N	21-26059 B			YORK TUBE-O SEAL
21-26067	21-26067 N	21-26067 B			YORK SERVICE VALVE SEAL
21-26086	21-26086 N	21-26086 B	21-26086 G		FORD FS6 SHELL SEAL
21-26092 (TEFLON)					HEATER CORE SPRINGLOCK SEAL
21-26093 (TEFLON)					HEATER CORE SPRINGLOCK SEAL

Metal Gaskets

21-84617	FORD FS6 COMPRESSOR
21-84623	FORD FX15
21-84628	FORD FX15
21-84629	FORD FX15
21-84642	FX15 / FS10
21-84644	FORD FS10

MISCELLANEOUS ITEMS

21-84727	#6 SPRING FOR SPRINGLOCK
21-84728	#8 SPRING FOR SPRINGLOCK
21-84729	#10 SPRING FOR SPRINGLOCK
21-84730	#12 SPRING FOR SPRINGLOCK

Black R12 (only)	Black R12 /R134a	Blue R12 /R134a	Green R12 /R134a	Yellow R12 /R134a
----------------------------	----------------------------	---------------------------	----------------------------	-----------------------------

O-Rings

40-02502	40-02502 N	40-02502 B	40-03501 G	40-02502 Y	#6 Hose Fitting O-Ring
40-02503	40-02503 N	40-02503 B	40-03502 G	40-02503 Y	#8 Hose Fitting O-Ring
40-02504	40-02504 N	40-02504 B	40-03503 G	40-02504 Y	#10 Hose Fitting O-Ring
40-02507	40-02507 N	40-02507 B	40-03504 G	40-02507 Y	#12 Hose Fitting O-Ring
40-02510	40-02510 N	40-02510 B	40-02510 G		Oil Tube O-Ring
40-02514	40-02514 N	40-02514 B	40-05214 G	40-02514 Y	Pressure Relief Valve / Oil Plug
40-02523	40-02523 N	40-02523 B	40-02523 G		Ford Heater Core O-Ring
40-02527	40-02527 N	40-02527 B	40-02527 G		Ford HR980 Shaft Seal O-Ring
40-02529	40-02529 N	40-02529 B	40-02529 G		Ford Service Valve O-Ring
40-02535	40-02535 N	40-02535 B	40-02535 G		Ford Exp. Valve O-Ring
40-02537	40-02537 N	40-02537 B	40-02537 G		Ford Comp. FS6 Service Valve O-Ring
40-02539	40-02539 N	40-02539 B	40-02539 G		Ford Comp. FS6 Shaft Seal O-Ring
40-02542	40-02542 N	40-02542 B	40-02542 G		Ford Comp. Suction / Discharge O-Ring
40-02542R			40-02542RG		Ford Comp. Suction / Discharge Oval O-Ring
40-02543	40-02543 N	40-02543 B	40-02543 G		Ford Block Valve O-Ring
40-02545	40-02545 N	40-02545 B	40-02545 G		Ford FS6 Cylinder Head O-Ring
40-02546	40-02546 N	40-02546 B	40-02546 G		Ford Orifice Tube O-Ring
40-02552	40-02552 N	40-02552 B	40-02552 G		Ford Compressor O-Ring
40-02556	40-02556 N	40-02556 B	40-02556 G		Ford Block Expansion Valve O-Ring
40-02559	40-02559 N	40-02559 B	40-02559 G		Ford Metric O-Ring
40-02602	40-02602 N	40-02602 B	40-02602 G		Ford Pressure Cycling Switch O-Ring
			40-02658 G		#10 Metric Springlock O-Ring
			40-02661 G		#12 Metric Springlock O-Ring
			40-02673 G		#8 Metric Springlock O-Ring
			40-02675 G		#6 Metric Springlock O-Ring

O-RINGS & GASKETS

GENERAL MOTORS

GM COMPRESSOR O-RINGS

Always Lubricate New O-Rings & Lathe Cut Gaskets with R12 or R134A Compatible Polyester Lubricant

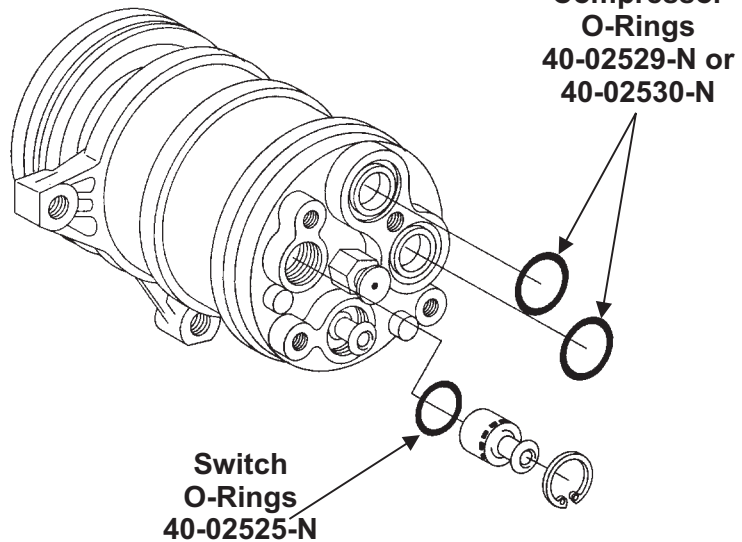

TYPICAL GM COMPRESSOR (REAR HEAD DISPLAY)

USE OF REMOVAL TOOL FOR GM DUAL O-RING JOINTS

Torque specification of all Dual O-Ring fittings is 18 Ft/Lbs.

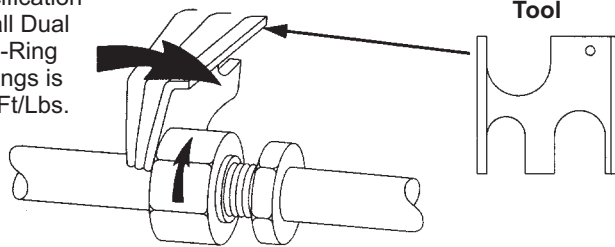

SELECT THE CORRECT TUBE O.D. SECTION OF TOOL AND INSTALL OVER THE TUBE WITH TOOL FLANGE FACING NUT

GM CAPTIVE O-RINGS

Starting in 1982 GM began using captive o-rings and fittings on their A/C hoses, condensers, evaporators and accumulators.

Captive o-rings are thicker than standard o-rings and are held in place by a groove on the connector tube.

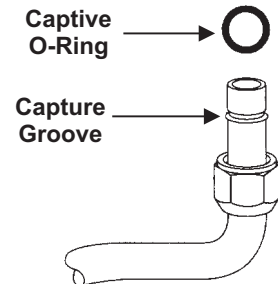

GM DUAL O-RING JOINT

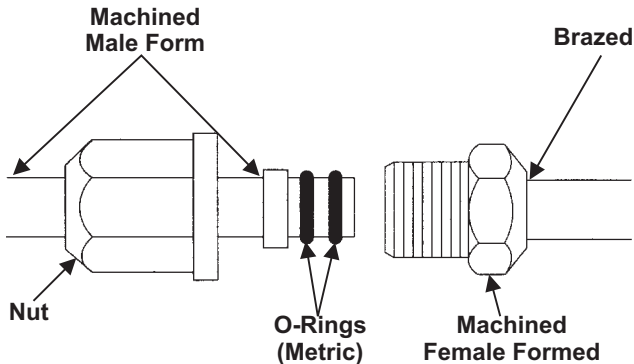

GM COMPRESSOR SPECIAL OVAL O-RINGS

40-02530-N
New (oval)

In 1988, GM replaced its old round compressor service O-Rings (40-02529-N) with the new OVAL compressor O-Rings (40-02530-N)

They are not interchangeable

40-02529-N
Old (round)

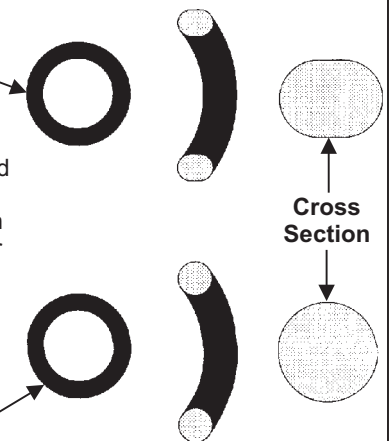

O-RINGS & GASKETS

GENERAL MOTORS

Kits

21-24651 B
GM BLUE CAPTIVE O-RING
ASSORTMENT KIT

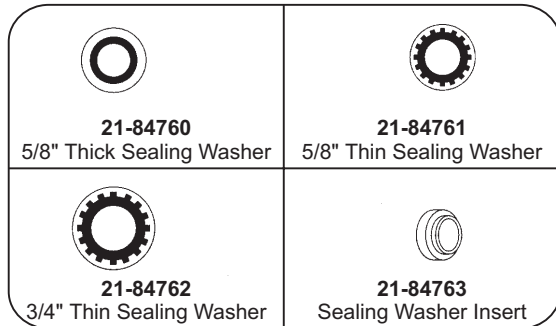
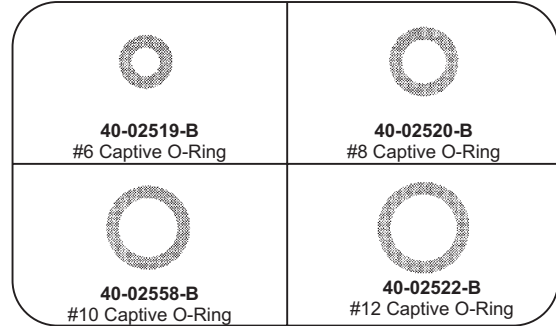

21-24652
GM SEALING WASHER ASSORTMENT
KIT

21-24657 B
GM METRIC & STANDARD CAPTIVE
O-RING ASSORTMENT

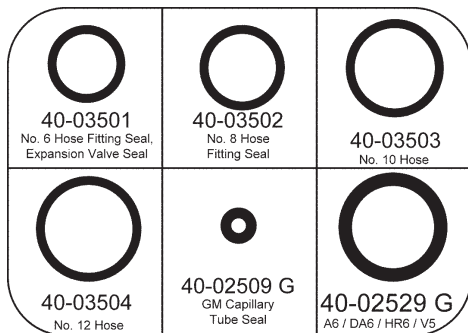
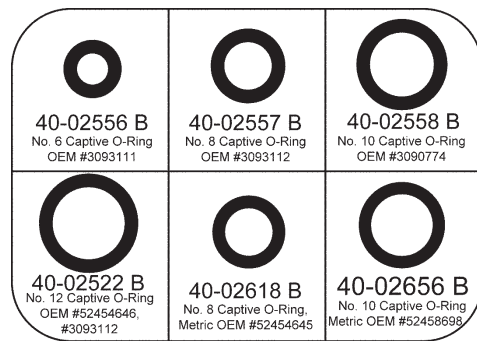



















21-24657 G
GM O-RING ASSORTMENT

























O-RINGS & GASKETS

GENERAL MOTORS

Kits

21-24702 GENERAL MOTORS ASSORTMENT KIT

 40-02509 GM Capillary	 40-02502 #6 Hose	 40-02503 #8 Hose	 40-02504 #10 Hose	 40-02507 #12 Hose	 40-02529 A6 / DA6 / HR6
 40-02519 #6 Captive	 40-02520 #8 Captive	 40-02558 #10 Captive	 40-02522 #12 Captive	 40-02525 Switch Port O-Ring	 40-02531 R4 Service Valve O-Ring
 21-26081 / 40-10250 Charging Hose Gasket/ Valve Core Depressor 1/4" (5 each)	 21-26083 / 41-90368 Charging Hose Gasket/ Valve Core Depressor 3/16" (5 each)	 21-26084 Top Can Tap Gasket (5 each)	 41-90377 Standard Refrigeration Valve Core (5 each)	 41-90379 Large Bore Valve Core (3 each)	 40-10257 / 40-10258 Plastic Valve Port Caps 3/16" & 1/4" (3 each)

 40-02509-B Expansion Valve	 40-02502-B #6 Hose Fitting	 40-02514-B Pressure Relief / V5	 40-02503-B #8 Hose Fitting / Drier	 40-02504 #10 Hose Fitting	 40-02507-B #12 Hose Fitting
 40-02519-B #6 Captive	 40-02520-B #8 Captive	 40-02558-B #10 Captive	 40-02522-B #12 Captive	 40-02529-B Standard Service	 40-02525-B Switch Port
 40-02530-B Oval Service	 40-02531-B R4 Service	 40-02534-B #8 (1/2") Dual	 40-02532-B #10 (5/8") Dual	 40-02533-B #12 (3/4") Dual	 21-84630 #8 (1/2") Dual
 21-84631 #10 (5/8") Dual (4 each)	 21-84632 #12 (3/4") Dual (4 each)	 21-84760 5/8" Thick (4 each)	 21-84763 Sealing	 21-84761 5/8" Thin Compressor (4 each)	 21-84762 3/4" Thin Compressor (4 each)

21-24703 B GENERAL MOTORS SERVICE ASSORTMENT KIT

21-24737 GENERAL MOTORS OEM R-134A SERVICE ASSORTMENT













40-02652 N Metric Orifice Tube O-Ring OEM #5245047 (Black Neoprene)	40-02653 N No. 8 - 1/2" Metric Captive O-Ring OEM #52454645 (Black Neoprene)	40-02654 N Metric Low Side Switch O-Ring OEM #52450548 (Black Neoprene)	40-02583 N Saturn Metric Block Fitting O-Ring OEM #52458698 (Black Neoprene)	40-02656 N No. 10 - 5/8" Metric Captive O-Ring OEM #52458698 (Black Neoprene)	40-02515 N Inline Filter O-Ring OEM #3094221 (Black Neoprene)
40-02562 N Saturn Metric Block Fitting O-Ring OEM #52455831 (Black Neoprene)	40-02660 N NO. 12 - 3/4" High Stretch Metric O-Ring OEM #52460742 (Black Neoprene)	40-02519 N NO. 6 Standard Captive O-Ring OEM #3093111 (Black Neoprene)	40-02615 N NO. 8 Standard Captive O-Ring OEM #3093112 (Black Neoprene)	40-02560 N Block Fitting O-Ring OEM #52451134 (Black Neoprene)	40-02558 N NO. 10 Standard Captive O-Ring OEM #3090774 (Black Neoprene)
40-02522 N NO. 12 Standard Captive O-Ring OEM #52454646 (Black Neoprene)	40-02524 N Block Fitting O-Ring OEM #52451133 (Black Neoprene)	40-02532 N NO. 10 - 5/8" Metric Dual Fitting O-Ring OEM #52456068 (Black Neoprene)	40-02533 N NO. 12 - 3/4" Metric Dual Fitting O-Ring OEM #52456069 (Black Neoprene)	40-02534 N No. 8 - 1/2" Metric Dual Fitting O-Ring OEM #52456067 (Black Neoprene)	21-84630 1/2" Dual Fitting Gasket OEM #52460714
21-84631 5/8" Dual Fitting Gasket OEM #52460715	21-84632 3/4" Dual Fitting Gasket OEM #52460716	21-84836 Green Retro Fit Sealing Washer OEM #2724890 (Neoprene) (5 per)	21-84839 Red Retro Fit Sealing Washer OEM #2724889 (Neoprene) (5 per)	21-84835 Yellow Retro Fit Sealing Washer OEM #2724888 (Neoprene) (5 per)	21-84840 Long Aluminum Pilot For Retro Fit OEM #2724891 (5 per)









O-RINGS & GASKETS

GENERAL MOTORS

Kits

**21-24738
GM SEALING WASHER
ASSORTMENT KIT**

 21-84703 Short Aluminum Pilot GM# 6559423	 21-84840 Long Aluminum Pilot GM# 2724891				
 21-84761 5/8\" Thin Sealing Washer GM# 52455752	 21-84762 3/4\" Thin Sealing Washer GM# 52455756	 21-84760 5/8\" Thick Black Sealing Washer GM# 52457910	 21-84836 Green Sealing Washer GM# 5724890	 21-84839 Red Sealing Washer GM# 2724889	 21-84835 Yellow Sealing Washer GM# 2724888

 40-02652 B Metric Orifice Tube O-Ring OEM# 52450547	 40-02653 B #8 Metric Captive O-Ring OEM# 52454645	 40-02654 B Metric Low Pressure O- Ring OEM# 52450548	 40-02583 B Saturn Metric Block Valve O- Ring OEM# 52455830	 40-02532 B #10 Metric Dual O-Ring OEM# 52456068	 40-02533 B #12 Metric Dual O-Ring OEM# 52456069
#10 Metric Captive O-Ring" data-bbox="101 576 151 606"/> 40-02656 B #10 Metric Captive O-Ring OEM# 52458698	 40-02562 B Saturn Metric Block Valve O-Ring OEM# 52455931	 40-02660 B #12 High Stretch Metric O-Ring OEM# 52460742	 40-02534 B #8 Metric Dual O-Ring OEM# 52456067		

**21-24739
GM METRIC O-RING KIT**

O-RINGS & GASKETS

GENERAL MOTORS

Lathe Cut Seals

Fiber Gaskets

21-26062

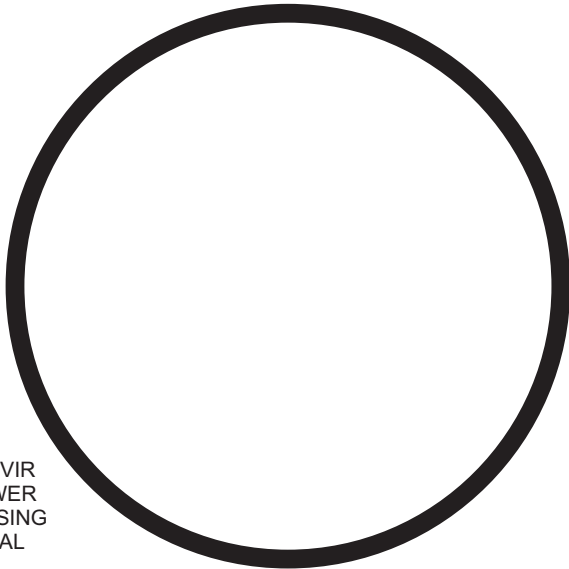

GM VIR
LOWER
HOUSING
SEAL

21-26040



GM A6 CLUTCH COIL FOAM DUST
PROTECTOR

21-26042



GM A6 REAR HEAD FLANGE
GASKET SET .003 THICK

21-26043



GM A6 FRONT NOSE GASKET
SET

Metal Gaskets

21-84618

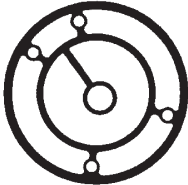

GM DA6 / HR6 HEAD GASKET

21-84620

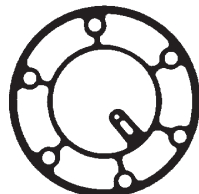

GM V5 VARIABLE
COMPRESSOR CYLINDER

21-84630



GM DUAL O-RING CONNECTION
1/2" SIZE

21-84631



GM DUAL O-RING CONNECTION
METAL BACKUP GASKET 5/8"

21-84632

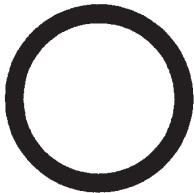

GM DUAL O-RING CONNECTION
METAL BACKUP GASKET 3/4"

21-84633

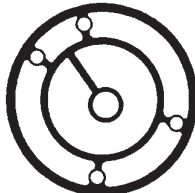

GM HR6 COMPRESSOR HEAD
GASKET

21-84634

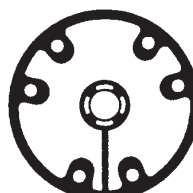

GM HR6 FRONT HEAD GASKET

21-84635

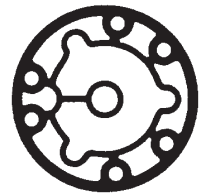

GM HR6 REAR HEAD GASKET

21-84640

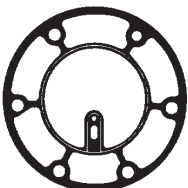











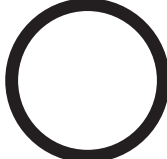





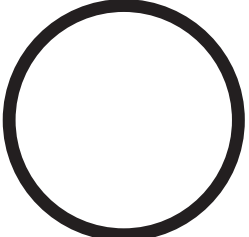



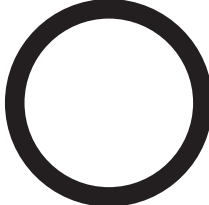
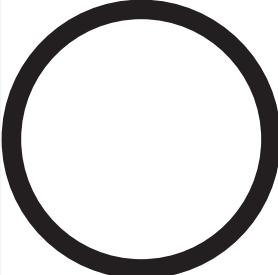
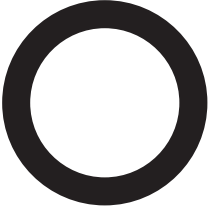
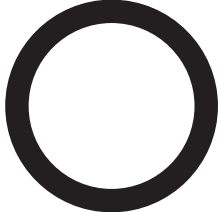
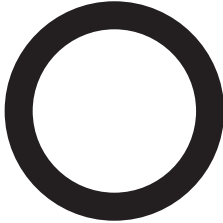
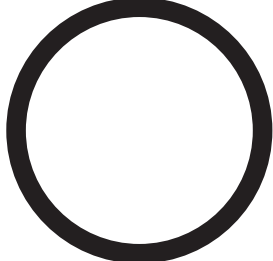

GM V5 VARIABLE CYLINDER HEAD
GASKET

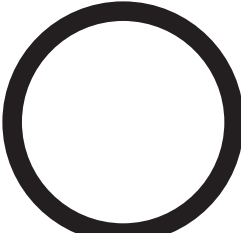
O-RINGS & GASKETS

GENERAL MOTORS

O-RINGS (actual size)

<p>40-03501</p>  <p>40-02502 #6 HOSE FITTING</p>	<p>40-03502</p>  <p>40-02503 #8 HOSE FITTING</p>	<p>40-03503</p>  <p>40-02504 #10 HOSE FITTING</p>	<p>40-03504</p>  <p>40-02507 #12 HOSE FITTING</p>	<p>40-02509</p>  <p>Capillary Tube O-Ring</p>		
<p>40-02510</p>  <p>OIL TUBE SEAL</p>	<p>40-02514</p>  <p>STANDARD CYCLING SWITCH O-RING</p>	<p>40-02515</p>  <p>INLINE FILTER O-RING</p>	<p>40-02516</p>  <p>Chry. Comp 6C17, Small Control Valve Port Seal</p>	<p>40-02518</p>  <p>A6 SWITCH PORT O-RING</p>		
<p>40-02519</p>  <p>#6 CAPTIVE O-RING OE#3093111</p>	<p>40-02522</p>  <p>#12 CAPTIVE O-RING OE#3093112</p>	<p>40-02524</p>  <p>GM V5 CONTROL VALVE O-RING</p>	<p>40-02525</p>  <p>GM SWITCH PORT SEAL</p>			
<p>40-02527</p>  <p>GM A6/R4 SHAFT SEAL O-RING</p>	<p>40-02529</p>  <p>MANIFOLD O-RING</p>	<p>40-02530</p>  <p>GM COMPRESSOR OVAL SERVICE O-RING</p>	<p>40-02531</p>  <p>R-4 SERVICE VALVE O-RING</p>	<p>40-02526</p>  <p>GM DA6 SHAFT SEAL</p>		
		<p>40-02532</p>  <p>5/8" METRIC DUAL FITTING O-RING 52456068</p>				
<p>40-02533</p>  <p>3/4" METRIC DUAL FITTING O-RING</p>	<p>40-02534</p>  <p>#8 1/2" METRIC DUAL FITTING O-RING 52456067</p>	<p>40-02551</p>  <p>GM HEAT SWITCH</p>	<p>40-02552</p> <p>SEE NEXT PAGE FOR DRAWING</p> <p>GM A6 SHELL O-RING</p>	<p>40-02553</p> <p>SEE NEXT PAGE FOR DRAWING</p> <p>GM A6 SHELL O-RING</p>	<p>40-02554</p> <p>SEE NEXT PAGE FOR DRAWING</p> <p>GM V5 SHELL O-RING</p>	<p>40-02555</p> <p>SEE NEXT PAGE FOR DRAWING</p> <p>GM R-4 SHELL O-RING</p>
<p>40-02556</p>  <p>GM #6 CAPTURED O-RING</p>	<p>40-02557</p>  <p>GM #8 CAPTURED O-RING</p>			<p>40-02558</p>  <p>GM CAPTURED #10</p>	<p>40-02559</p>  <p>GM CLUTCH CYCLING SWITCH O-RING</p>	<p>40-02560</p>  <p>GM VIR SIGHT GLASS</p>

O-RINGS & GASKETS

GENERAL MOTORS



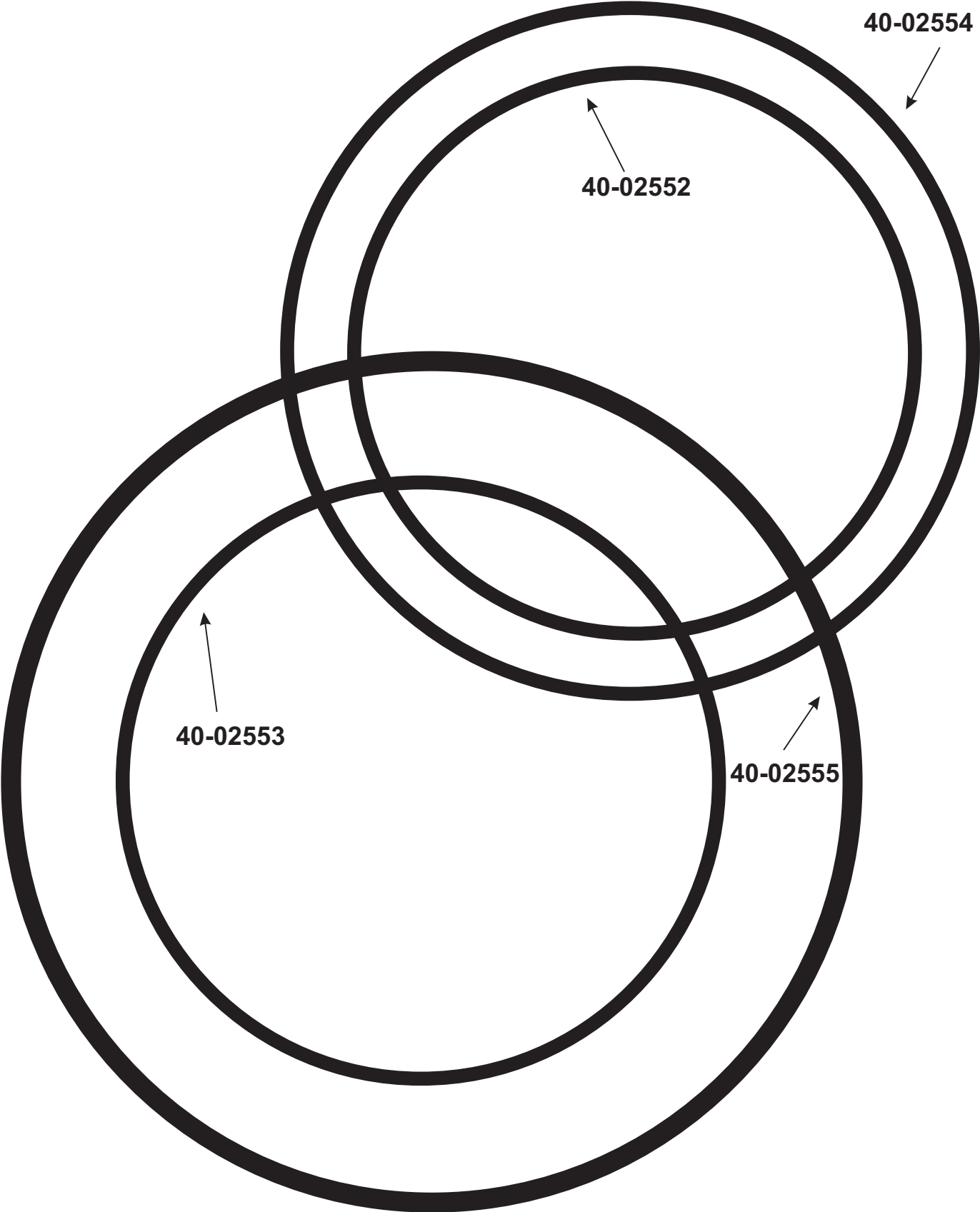







O-RINGS (actual size)

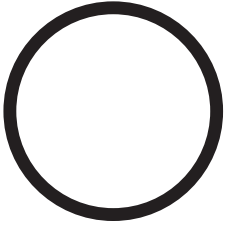
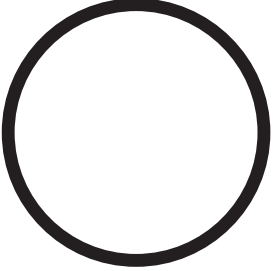
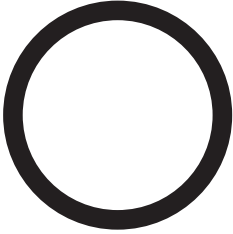
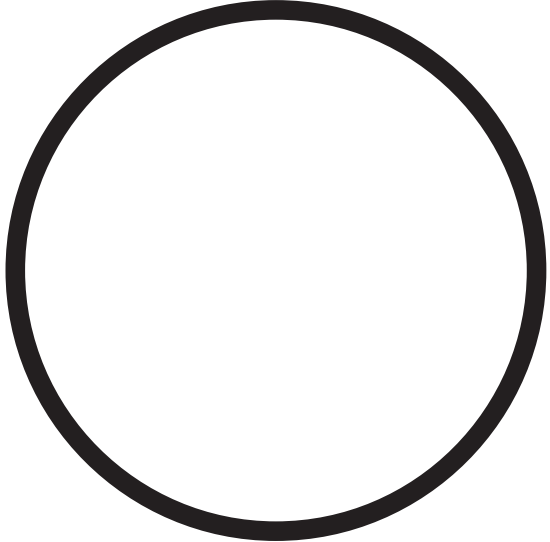
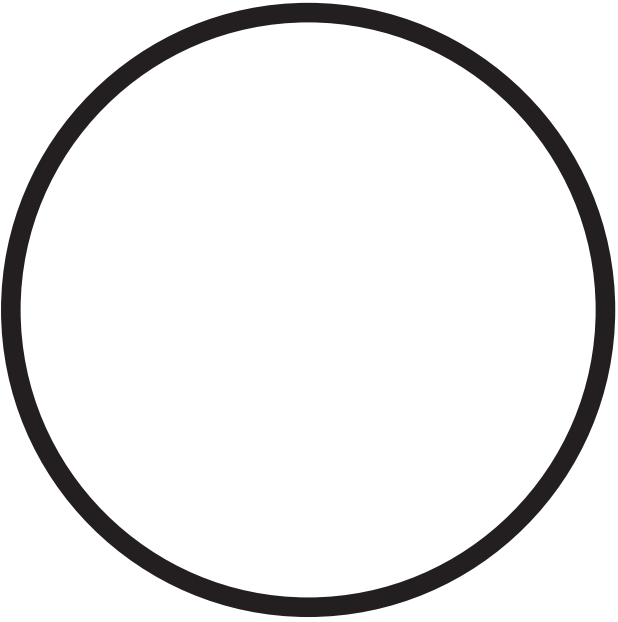

O-RINGS & GASKETS

GENERAL MOTORS







O-RINGS (actual size)

<p>40-02562</p>  <p>SATURN METRIC O-RING OE# 52455831</p>	<p>40-02583</p>  <p>SATURN METRIC O-RING OE# 52458698</p>	<p>40-02615</p>  <p>GM #8 CAPTURED</p>	<p>40-02618</p>  <p>RETRO FIT ADAPTER</p>	<p>40-02621</p>  <p>GM VIR EXPANSION VALVE O-RING</p>
<p>40-02623</p>  <p>GM VIR POA VALVE O-RING</p>	<p>40-02636</p>  <p>GM A6 COMPRESSOR O-RING</p>	<p>40-02638</p>  <p>GM VIR LOWER SHELL O-RING</p>		
<p>40-02640</p>  <p>GM VIR UPPER SHELL O-RING</p>		<p>40-02652</p>  <p>METRIC ORIFICE TUBE O-RING</p>	<p>40-02653</p>  <p>METRIC CAPTIVE O-RING</p>	<p>40-02654</p>  <p>METRIC LOW SIDE SWITCH O-RING</p>
<p>40-02656</p>  <p>METRIC CAPTIVE O-RING</p>		<p>40-02660</p>  <p>METRIC CAPTIVE O-RING</p>		

O-RINGS & GASKETS

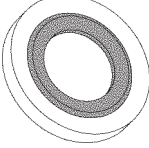
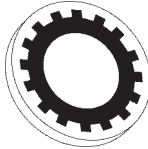
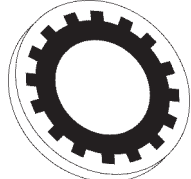
GENERAL MOTORS

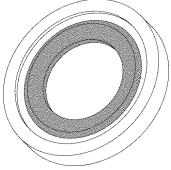
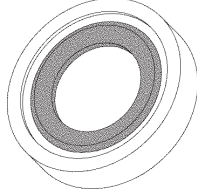
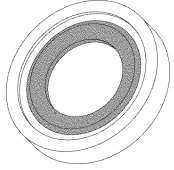
Miscellaneous Items

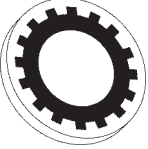
<p>21-84630</p>  <p>1/2" DUAL FITTING GASKET OE# 52460714</p>	<p>21-84631</p>  <p>5/8" DUAL FITTING GASKET OE# 52460715</p>	<p>21-84632</p>  <p>3/4" DUAL FITTING GASKET OE# 52460716</p>	<p>21-84760</p>  <p>5/8" THICK SEALING WASHER</p>
<p>21-84761</p>  <p>5/8" THIN SEALING WASHER</p>	<p>21-84762</p>  <p>3/4" THIN SEALING WASHER</p>	<p>21-84763</p>  <p>SEALING WASHER INSERT</p>	<p>21-84835</p>  <p>GM YELLOW THICK SEALING WASHER GM #2724888</p>
<p>21-84836</p>  <p>GM GREEN THICK SEALING WASHER GM # 2724890</p>	<p>21-84839</p>  <p>GM RED THICK SEALING WASHER GM # 2724889</p>	<p>21-84840</p>  <p>GM LONG ALUMINUM PILOT FOR NEW STYLE SEALING WASHERS GM#2724891</p>	<p>21-24790</p>  <p>13mm SEALING WASHER OE# 2724952</p>

O-RINGS & GASKETS

GENERAL MOTORS

Assortment Kits

21-24651 B	GM Blue Captive O-Ring Assortment Kit
21-24652	GM Sealing Washer Assortment Kit
21-24657 B	GM Metric & Standard Captive O-Ring Assortment Kit
21-24657 G	GM O-Ring Assortment Kit
21-24702	GM Assortment Kit
21-24703 B	GM Service Assortment Kit
21-24737	GM OEM R134A Service Assortment Kit
21-24738	GM Sealing Washer Assortment Kit
21-24739	GM Metric O-Ring Assortment Kit

Black R12 (only)	Black R12 /R134a	Blue R12 /R134a	Green R12 /R134a	Yellow R12 /R134a
---------------------	---------------------	--------------------	---------------------	----------------------

Lathe Cut Seals

21-26062	21-26062 N	21-26062 B	Lathe Cut VIR lower shell	
-----------------	-------------------	-------------------	---------------------------	--

Fiber Gaskets

21-26040	GM A6 Clutch Coil Foam Dust Protector
21-26042	GM A6 Rear Head Flange Gasket
21-26043	GM A6 Front Nose Gasket Set

Metal Gaskets

21-84618	GM DA6 / HR6 Head Gasket
21-84620	GM V5 Variable Compressor Cylinder Head
21-84630	GM Dual O-Ring Connection 1/2"
21-84631	GM Dual O-Ring Connection 5/8"
21-84632	GM Dual O-Ring Connection 3/4"
21-84633	GM HR6 Compressor Head Gasket
21-84634	GM HR6 Front Head Gasket
21-84635	GM HR6 Rear Head Gasket
21-84640	GM V5 Variable Cylinder Head Gasket

Black R12 (only)	Black R12 /R134a	Blue R12 /R134a	Green R12 /R134a	Yellow R12 /R134a
---------------------	---------------------	--------------------	---------------------	----------------------

O-Rings

40-02502	40-02502 N	40-02502 B	40-03501	40-02502 Y	#6 Hose Fitting O-Ring
40-02503	40-02503 N	40-02503 B	40-03502	40-02503 Y	#8 Hose Fitting O-Ring
40-02504	40-02504 N	40-02504 B	40-03503	40-02504 Y	#10 Hose Fitting O-Ring
40-02507	40-02507 N	40-02507 B	40-03504	40-02507 Y	#12 Hose Fitting O-Ring
40-02509	40-02509 N	40-02509 B	40-02509 G		Capillary Tube O-Ring
40-02510	40-02510 N	40-02510 B	40-02510 G		Oil Tube O-Ring
40-02514	40-02514 N	40-02514 B	40-02514 G		Standard Cycling Switch O-Ring
40-02515	40-02515 N	40-02515 B	40-02515 G		Inline Filter O-Ring
40-02516	40-02516 N	40-02516 B	40-02516 G		Service Item O-Ring
40-02518	40-02518 N	40-02518 B	40-02518 G		A6 Switch Port O-Ring
40-02519	40-02519 N	40-02519 B	40-02519 G		#6 Captive O-Ring 3093111
40-02522	40-02522 N	40-02522 B	40-02522 G		#12 Captive O-Ring 3093112
40-02524	40-02524 N	40-02524 B	40-02524 G		GM V5 Control Valve O-Ring
40-02525	40-02525 N	40-02525 B	40-02525 G		GM Switch Port Seal
40-02526	40-02526 N	40-02526 B	40-02526 G		GM DA6 Shaft Seal
40-02527	40-02527 N	40-02527 B	40-02527 G		GM A6 / R4 Shaft Seal O-Ring
40-02529	40-02529 N	40-02529 B	40-02529 G		Manifold O-Ring
40-02530	40-02530 N	40-02530 B	40-02530 G		GM Compressor Oval Service O-Ring
40-02531	40-02531 N	40-02531 B	40-02531 G		R4 Service Valve O-Ring
40-02532	40-02532 N	40-02532 B	40-02532 G		5/8" Metric Dual O-Ring 52456068
40-02533	40-02533 N	40-02533 B	40-02533 G		3/4" Metric Dual O-Ring 52456069
40-02534	40-02534 N	40-02534 B	40-02534 G		1/2" Metric Dual O-Ring 52456067
40-02551	40-02551 N	40-02551 B	40-02551 G		GM Heat Switch O-Ring
40-02554	40-02554 N	40-02554 B	40-02554 G		GM V5 Shell O-Ring
40-02555	40-02555 N	40-02555 B	40-02555 G		GM R4 Shell O-Ring
40-02556	40-02556 N	40-02556 B	40-02556 G		GM #6 Captured O-Ring
40-02557	40-02557 N	40-02557 B	40-02557 G		GM #8 Captured O-Ring
40-02558	40-02558 N	40-02558 B	40-02558 G		GM #10 Captured O-Ring
40-02559	40-02559 N	40-02559 B	40-02559 G		GM Clutch Cycling Switch O-Ring
40-02560	40-02560 N	40-02560 B	40-02560 G		GM VIR Sight Glass O-Ring
40-02562	40-02562 N	40-02562 B	40-02562 G		Saturn Metric O-Ring
40-02583	40-02583 N	40-02583 B	40-02583 G		Saturn Metric O-Ring
40-02615	40-02615 N	40-02615 B	40-02615 G		GM #8 Captured O-Ring
40-02618	40-02618 N	40-02618 B	40-02618 G		Retro Fit Adapter
40-02621	40-02621 N	40-02621 B	40-02621 G		GM VIR Expansion Valve O-Ring
40-02623	40-02623 N	40-02623 B	40-02623 G		GM VIR POA Valve O-Ring

O-RINGS & GASKETS

GENERAL MOTORS

Black R12 (only)	Black R12 /R134a	Blue R12 /R134a	Green R12 /R134a	Yellow R12 /R134a
---------------------	---------------------	--------------------	---------------------	----------------------

O-Rings

40-02636	40-02636 N	40-02636 B	40-02636 G	GM A6 Compressor O-Ring
40-02638	40-02638 N	40-02638 B	40-02638 G	GM VIR Lower Shell O-Ring
40-02640	40-02640 N	40-02640 B	40-02640 G	GM VIR Upper Shell O-Ring
	40-02652 N			Metric Orifice Tube O-Ring
	40-02653 N			Metric Captive O-Ring
	40-02654 N			Metric Low Side Switch O-Ring
	40-02656 N			Metric Captive O-Ring
	40-02660 N			Metric Captive O-Ring

Miscellaneous Items

21-84630	1/2" Dual Fitting Gasket 52460714
21-84631	5/8" Dual Fitting Gasket 52460715
21-84632	3/4" Dual Fitting Gasket 52460716
21-84760	5/8" Thick Sealing Washer
21-84761	5/8" Thin Sealing Washer
21-84762	3/4" Thin Sealing Washer
21-84763	Sealing Washer Insert
21-84835	GM Yellow Thick Sealing Washer 2724888
21-84836	GM Green Thick Sealing Washer 2724890
21-84839	GM Red Thick Sealing Washer 2724889
21-84840	GM Long Aluminum Pilot For New Style Sealing Washer 2724891
21-24790	13MM Sealing Washer 2724952

O-RINGS & GASKETS

IMPORTS

BEHR

CALSONIC

PANASONIC

HITACHI

KEIHIN

MATSUSHITA

MITSUBISHI

BOSCH

SEIKO-SEIKI

NIHON









NIPPONDENSO







O-RINGS & GASKETS

IMPORTS

KITS







**21-24655
VOLVO BLUE ASSORTMENT KIT** →

 40-02507 92477-N8200 19MM O-Ring		 40-02529 J2657-06W50 Flange O-Ring		 41-90380 999AL-A5000 Valve Core	
 40-02510 92470-N8200 8MM O-Ring	 40-02502 92474-N8200 10MM O-Ring	 40-10257 999AL-85000 (3/16") 3/8" Cap		 40-02560 92475-W1000 12MM Flange O-Ring	
 40-02503 92471-N8200 12MM O-Ring		 40-02516 27739-B8065 Comp. O-Ring			













 40-02509 / 40-02644 Capillary Tube Seal / Block Fitting O-Ring (Blue Neoprene)	 40-02502 No. 6 Hose Fitting O-Ring (Blue Neoprene)	 40-02514 Cycling Pres. Sw. O-Ring (Blue Neoprene)
 40-02503 No. 8 Hose Fitting O-Ring (Blue Neoprene)	 40-02504 No. 10 Hose Fitting O-Ring (Blue Neoprene)	 40-02507 No. 12 Hose Fitting / Accumulator O-Ring (Blue Neoprene)

← **21-24705
INFINITI, NISSAN R12 & R13a
SERVICE O-RING ASSORTMENT**













→ **21-24707
VOLVO RETRO FIT O-RING
ASSORTMENT KIT (YELLOW)**

 40-02512 Y Metric Office Tube O-Ring OEM #1323387-9	 40-02502 Y No. 6 Hose Fitting O-Ring OEM #3522588-7, 3557499-0	 40-02514 Y Cycling Pres. Sw. O-Ring OEM #3522598-6, 3737501-3
 40-02503 Y No. 8 Hose Fitting O-Ring OEM #3522591-0 3537503-9	 40-02504 Y No. 10 Hose Fitting O-Ring OEM #3522590-3 3537507-0	 40-02507 Y No. 12 Hose Fitting /Accum. O-Ring OEM #3522591-0 3337521-1

← **21-24708
METRIC / IMPORT O-RING
ASSORTMENT KIT**

 40-02514-G Toyota Pressure Switch	 40-03502 Nissan 12mm / Toyota	 40-03503 Mazda/Mitsubishi Hose	 40-02512-G Toyota #5 14mm
 40-02564-G Nissan #6 (6mm)	 40-02510-G Nissan #8 (8mm)	 40-03501 Nissan #10 (10mm) / Mazda/Hyundai	 40-02522-G Mitsubishi Comp. FX80 Suction Port O-Ring
 40-03503 Mazda/Mitsubishi Hose Fitting / Nissan	 40-02560-G Nissan Cond. Block Fitting	 40-02502 Nissan 12mm / Toyota	 40-02542-G Nipp. Suc./Dis.Port / H/Rachi, Matsushita, Nipp. Suc./Dis Valve O-Ring

→ **21-24709
METRIC / STANDARD O-RING
ASSORTMENT KIT**

 40-02512-G #5 (7mm) Toyota Hose	 40-02510-G Nissan #8 Hose Fitting	 40-03501 Nissan #10 Hose	 40-02514-G Comp. Switch Port / Oil Plug
 40-03502 #8 Hose Fitting	 40-03503 Nissan Evaporator	 40-02560-G	 40-02523-G Diesel Kiki / Sanden Service Valve Green O-Ring
 40-02542-G Nippondenso Service Valve Green O-Ring	 40-02543-G Diesel Kiki Service	 40-02564-G Nissan #6 Hose	 40-02612-G Sanden Oil Plug / Mitsubishi FX105 Rear Housing Green O-Ring

O-RINGS & GASKETS

IMPORTS

KITS

40-02512 7MM Metric Hose, Drier, TXV O-Ring (Green HNBR)	40-02509 TXV, Equalizer, Evaporator, Oil Bleed O-Ring (Green HNBR)	40-02559 Office Tube O-Ring (Green HNBR)	40-03501 No. 6 Hose Fitting, Drier, TXV O-Ring (Green HNBR)	40-02543 Sanden / Diesel Kiki Compressor Manifold O-Ring (Green HNBR)	40-02529 GM A6 Compressor Service Post O-Ring (Green HNBR)
40-02514 Cycling Switch, Pressure Switch O-Ring (Green HNBR)	40-03502 No. 8 Hose Fitting, Drier, TXV O-Ring (Green HNBR)	40-03503 No. 10 Hose Fitting, Tube-O Fitting, York Tube-O-Ring (Green HNBR)	40-03504 No. 12 Hose Fitting, Evaporator, VIR TXV, Accumulator O-Ring (Green HNBR)	21-26051 York Compressor Rotolock Seal	21-26081 York Compressor Flange Seal (Blue Neoprene)
40-02621 VIR POA Valve O-Ring (Blue Neoprene)	40-02523 Sanden / Diesel Kiki Compressor 15MM I.D. Manifold O-Ring (Green HNBR)	40-02524 Sanden / Diesel Kiki Compressor 17MM I.D. Manifold O-Ring (Green HNBR)	40-02542 Nippondenso 6P / 10P Sanden Compressor 18MM I.D. Manifold O-Ring (Green HNBR)		

21-24764
← **AUDI / VOLKSWAGEN SERVICE O-RING ASSORTMENT KIT**

21-24765
BMW SERVICE ASSORTMENT KIT →

40-02509 Expansion Valve, Equalizer O-Ring (HNBR Green)	40-03501 No. 6 Hose Fitting, Drier, Expansion Valve O-Ring OEM #64501468463 (HNBR Green)	40-03502 No. 8 Hose Fitting, Drier, Expansion Valve O-Ring OEM # 64501468464, 64508390802 (HNBR Green)	40-03503 No. 10 Hose Fitting, Evaporator, Condenser O-Ring (HNBR Green)
40-03504 No. 12 Hose Fitting, Evaporator O-Ring OEM #6450146846C (HNBR Green)	40-02542 Nippondenso Compressor Manifold O-Ring (HNBR Green)	21-26067 York Flange Lathe Cut Seal (Blue Neoprene)	21-26051 York Rotolock Teflon Seal

40-02512 7MM Hose Fitting, Expansion Valve O-Ring (Green HNBR)	40-02509 Equalizer Line O-Ring (Green HNBR)	40-03501 No. 6 Hose Fitting, Drier, Expansion Valve O-Ring (Green HNBR)	40-02514 Switch O-Ring (Green HNBR)
40-03502 No. 8 Standard Hose Fitting, Drier, Condenser O-Ring (Green HNBR)	40-03503 No. 10 Standard Hose Fitting, Compressor Fitting O-Ring (Green HNBR)	40-02585 Nippondenso 10PO8E Compressor Inner Manifold O-Ring (Blue Neoprene)	40-03504 No. 12 Standard Hose Fitting, Evaporator O-Ring (Green HNBR)
40-02542 Nippondenso Compressor Manifold O-Ring 18MM I.D. (Green HNBR)	40-02612 6MM Hose Fitting, Drier O-Ring (Green HNBR)	40-02650 13MM Block O-Ring (Blue Neoprene)	40-02537 Nippondenso Compressor Manifold O-Ring 19MM I.D. (Green HNBR)

21-24766
← **GEO SERVICE O-RING KIT**

21-24767
HONDA / ACURA SERVICE O-RING ASSORTMENT KIT →

40-02512 7MM Hose Fitting, Drier, TXV O-Ring (Green HNBR)	40-02509 Evaporator, TXV, Equalizer Line O-Ring (Green HNBR)	40-02559 6MM Hose Fitting O-Ring (Green HNBR)	40-03501 No. 6 Standard Hose Fitting, Drier, TXV O-Ring (Green HNBR)	40-02582 Hitachi Compressor, Manifold, 1/2" Metric Condenser O-Ring OEM #60872-S17-000 (Blue Neoprene)	40-02514 PRV Switch O-Ring (Green HNBR)
40-03502 No. 8 Standard Hose Fitting, Drier, TXV O-Ring (Green HNBR)	40-02584 5/8" Metric O-Ring OEM #80671-S17-000 (Blue Neoprene)	40-03503 No. 10 Standard Hose Fitting, Condenser Manifold O-Ring (Green HNBR)	40-03504 No. 12 Standard Hose Fitting, Evaporator O-Ring (Green HNBR)	40-02560 10MM I.D. Block Fitting, Compressor Manifold O-Ring (Green HNBR)	40-02523 15MM I.D. Compressor Manifold O-Ring (Green HNBR)
40-02524 17MM I.D. Compressor Manifold O-Ring (Green HNBR)	40-02542 18MM I.D. Compressor Manifold O-Ring (Green HNBR)	40-02543 20MM I.D. Compressor Manifold O-Ring (Green HNBR)	40-02564 Oil Bleed Capillary O-Ring (Green HNBR)	40-02560 Hitachi Compressor, Manifold O-Ring (Blue Neoprene)	40-02537 Compressor Manifold O-Ring (Green HNBR)

O-RINGS & GASKETS

IMPORTS

KITS

40-02509 Expansion Valve Equalizer O-Ring (Green HNBR)	40-02602 Cycling Switch Metric O-Ring (Green HNBR)	40-03501 No. 6 Standard Hose Fitting, Springlock, Drier, TXV O-Ring (Green HNBR)	40-02514 Cycling Switch Standard O-Ring (Green HNBR)	40-03502 No. 8 Standard Hose Fitting, Springlock, Evaporator, Condenser O-Ring (Green HNBR)	40-02658 No. 10 Metric Springlock O-Ring (Green HNBR)
40-03503 No. 10 Standard Hose Fitting, Springlock, Evaporator, Condenser O-Ring (Green HNBR)	40-02661 No. 12 Metric Springlock O-Ring (Green HNBR)	40-03504 No. 12 Standard Hose Fitting, Springlock, Evaporator O-Ring (Green HNBR)	40-02603 Diesel Kiki CH Compressor Discharge O-Ring (Blue Neoprene)	40-02605 Diesel Kiki CH Compressor Suction O-Ring (Blue Neoprene)	40-02523 Diesel Kiki BH Compressor Discharge O-Ring (Green HNBR)
40-02524 Diesel Kiki BH Compressor Suction O-Ring (Green HNBR)	40-02542 Nippondenso 6P / 10P Compressor Manifold O-Ring (Green HNBR)	40-02529 FX15 / FS10 Compressor Port O-Ring (Green HNBR)	40-02546 Orifice Tube, Drier O-Ring (Green HNBR)	21-84729 No. 10 Springlock Garter Spring (5 PER)	21-84730 No. 12 Springlock Garter Spring (5 PER)

← **21-24768**
HYUNDAI SERVICE O-RING ASSORTMENT KIT

21-24769 G
MERCEDES SERVICE O-RING KIT →

40-02509 TXV, Equalizer, Evaporator Oil Bleed O-Ring (Green HNBR)	40-03501 No. 6 Hose Fitting, Drier, TXV O-Ring (Green HNBR)	40-02514 Cycling Switch High Pressure Cut Out Switch O-Ring (Green HNBR)	40-03502 No. 8 Hose Fitting, Drier, TXV O-Ring OEM #123-997-03-40 (Green HNBR)	40-03503 No. 10 Hose Fitting, TXV O-Ring (Green HNBR)	40-03504 No. 12 Hose Fitting, Evaporator O-Ring (Green HNBR)
40-02542 Compressor Manifold O-Ring (Green HNBR)	40-02692 Metric O-Ring OEM #140-997-06- (Green HNBR)	40-02693 Metric O-Ring OEM #140-997-07-45 (Green HNBR)	40-02609 Metric O-Ring OEM #140-997-06-45 (Green HNBR)	40-02691 Metric O-Ring OEM #140-997-09-45 (Green HNBR)	21-26051 York Rotolock Teflon Seal
21-26067 York Flange Lathe Cut Seal (Blue Neoprene)	40-02529 GM / Nippondenso Compressor O-Ring (Green HNBR)	40-02531 GM R4 Compressor O-Ring (Green HNBR)	21-84760 GM R4 Compressor 5/8" I.D. Thick Sealing Washer (Neoprene) (6 per)	21-84761 GM R4 Compressor 5/8" I.D. Thin Sealing Washer (Neoprene) (6 per)	21-84762 GM R4 Compressor 3/4" I.D. Thin Sealing Washer (Neoprene) (6 per)

40-02509 TXV, Equalizer Line O-Ring (Green HNBR)	40-03501 No. 6 Hose Fitting, Drier, TXV O-Ring (Green HNBR)	40-02514 9MM Switch O-Ring (Green HNBR)	40-03502 No. 8 Hose Fitting, TXV O-Ring OEM #MB946605 (Green HNBR)	40-02523 Compressor Sensor O-Ring (Green HNBR)	40-02542 Nippondenso 6P / 10P Compressor, Manifold Lip Shaft Seal O-Ring (Green HNBR)
40-02515 Control Valve Inner O-Ring (Green HNBR)	40-03503 No. 10 Standard Hose Fitting, Springlock, Drier O-Ring OEM #946606 (Green HNBR)	40-02516 Control Valve Outer O-Ring (Green HNBR)	40-03504 No. 12 Hose Fitting, Evaporator O-Ring (Green HNBR)	40-02529 Nippondenso 10PA Compressor Manifold O-Ring (Green HNBR)	21-84729 No. 10 Springlock Garter Spring (5 per)
40-02512 7MM Metric Hose, Drier, TXV O-Ring OEM #MS946604 (Green HNBR)	40-02612 16MM Metal Hose Fitting, Drier, TXV O-Ring (Green HNBR)	40-02560 Compressor Discharge Port O-Ring (Green HNBR)	40-02522 Compressor Suction Port O-Ring (Green HNBR)	40-02658 #10 Metric Springlock Accumulator O-Ring (Green HNBR)	40-02510 6MM Switch O-Ring (Green HNBR)

← **21-24770 G**
MITSUBISHI SERVICE O-RING ASSORTMENT









21-24771 G
PORSCHE O-RING SERVICE KIT ASSORTMENT KIT →

40-02512 7MM (#5) Metric Hose Fitting, TXV, Filter Drier O-Ring	40-02509 Evaporator Oil Bleed Line, Expansion Valve Equalizer O-Ring	40-03501 No. 6 Standard Hose Fitting, Filter Drier Expansion Valve O-Ring	40-03502 No. 8 Standard Hose Fitting, Filter Drier Expansion Valve O-Ring
40-03503 No. 10 Standard Hose Fitting, Compressor, Evaporator, Condenser O-Ring	40-03504 No. 12 Standard Hose Fitting, Evaporator O-Ring	40-02542 Nippondenso & Sanden Compressor Hose Manifold O-Ring	40-02692 7MM Metric Service O-Ring OEM #99970724740
40-02694 9MM Metric Service O-Ring OEM #99970726140	40-02693 10MM Metric Service O-Ring OEM #99970725040	40-02609 14MM Metric Service O-Ring OEM #99970725140	40-02691 17MM Metric Service O-Ring OEM #99970725240

O-RINGS & GASKETS











IMPORTS



















KITS

 40-02509 Equalizer Valve O-Ring (HNBR Green)	 40-02510 Switch O-Ring (HNBR Green)	 40-03501 No. 6 Hose Fitting, Drier, Expansion Valve O-Ring (HNBR Green)	 40-02514 PRV / Switch O-Ring (HNBR Green)
 40-03502 No. 8 Hose Fitting, Expansion Valve, Condenser O-Ring (HNBR Green)	 40-03503 No. 10 Hose Fitting, Compressor, Condenser O-Ring (HNBR Green)	 40-03504 No. 12 Hose Fitting, Evaporator O-Ring (HNBR Green)	 40-02529 Seiko Seiki Compressor Port O-Ring (HNBR Green)

21-24772 G
SAAB SERVICE ASSORTMENT KIT

























21-24773
SUBARU SERVICE O-RING
ASSORTMENT KIT

 40-02512 7MM Hose Fitting, Expansion Valve O-Ring (Green HNBR)	 40-02509 Equalizer Line O-Ring (Green HNBR)	 40-02510 Oil Bleed, Switch O-Ring (Green HNBR)	 40-03501 No. 6 Standard Hose Fitting, Drier, Expansion Valve O-Ring (Green HNBR)
 40-03502 No. 8 Standard Hose Fitting, Drier, Condenser O-Ring (Green HNBR)	 40-03503 No. 10 Standard Hose Fitting, Condenser Fitting O-Ring (Green HNBR)	 40-03504 No. 12 Standard Hose Fitting, Evaporator O-Ring (Green HNBR)	 21-26051 York Teflon Rotolock Seal
 21-26067 York Flange Lathe Cut Seal (Blue Neoprene)	 40-02565 Hitachi Compressor 16MM Flange O-Ring (Blue Neoprene)	 40-02542 Hitachi Compressor Metric 12MM Flange, Condenser O-Ring (Green HNBR)	 40-02612 16MM Fitting, Drier, Expansion Valve O-Ring (Green HNBR)

 40-02512 7MM Metric Pad Drier, TXV O-Ring (Green HNBR)	 40-02509 Equalizer Line O-Ring (Green HNBR)	 40-02559 Orifice Tube O-Ring (Green HNBR)	 40-03501 No. 6 Hose Fitting, Drier, TXV O-Ring (Green HNBR)	 40-02514 Cycling / Pressure Switch O-Ring (Green HNBR)	 40-03502 No. 8 Hose Fitting, Drier, Condenser O-Ring (Green HNBR)
 40-03503 No. 10 Hose Fitting, Evaporator, Condenser, Drier (Green HNBR)	 40-03504 No. 12 Hose Fitting, Evaporator O-Ring (Green HNBR)	 40-02517 Diesel Kiki Compressor Discharge Port O-Ring (Blue Neoprene)	 40-02535 Diesel Kiki Compressor Suction Port O-Ring (Blue Neoprene)	 40-02524 Sanden Compressor Discharge Port O-Ring (Green HNBR)	 40-02543 Sanden Compressor Suction Port O-Ring (Green HNBR)
 40-02531 GM R4 Compressor Port O-Ring (Green HNBR)	 40-02546 16MM Drier O-Ring (Green HNBR)	 21-84760 GM Compressor 5/8" I.D. Thick Sealing Washer (Neoprene)	 21-84761 GM Compressor 5/8" I.D. Thin Sealing Washer (Neoprene)	 21-84762 GM Compressor 3/4" I.D. Thin Sealing Washer (Neoprene)	 21-84763 GM Compressor Aluminum Pilot For 5/8" I.D. Thick Sealing Washer

21-24774
ISUZU SERVICE O-RING
ASSORTMENT KIT

21-24776 G
MAZDA SERVICE O-RING
ASSORTMENT KIT

 40-02512 7MM Hose, Drier, TXV O-Ring (Green HNBR)	 40-03501 No. 6 Standard Hose, Drier, Springlock, TXV O-Ring (Green HNBR)	 40-02559 8MM Hose Fitting O-Ring (Green HNBR)	 40-02509 TXV, Oil Bleed Line O-Ring (Green HNBR)	 40-03502 No. 8 Standard Hose, Drier, Springlock O-Ring (Green HNBR)	 40-02602 8MM Hose, R-134a Cycling Switch O-Ring (Green HNBR)
 40-02673 No. 8 Metric Springlock O-Ring (Green HNBR)	 40-02673 No. 6 Metric Springlock O-Ring (Green HNBR)	 40-02658 No. 10 Metric Springlock O-Ring (Green HNBR)	 40-02661 No. 12 Metric Springlock O-Ring (Green HNBR)	 40-03503 No. 10 Standard Hose, Springlock O-Ring	 40-03504 No. 12 Standard Hose, Springlock O-Ring
 40-02523 15MM Compressor Manifold O-Ring (Green HNBR)	 40-02524 17MM Compressor Manifold O-Ring (Green HNBR)	 40-02542 Nisp./Sanden 18MM I.D. Compressor Manifold O-Ring (Green HNBR)	 40-02543 20MM Compressor Manifold O-Ring (Green HNBR)	 40-02529 Nippondenso / Sanden Compressor Manifold O-Ring (Green HNBR)	 40-02612 16MM Type Fitting O-Ring (Green HNBR)
 40-02546 Orifice Tube, Hose Fitting O-Ring (Green HNBR)	 40-02537 Nippondenso 19MM I.D. Compressor Manifold O-Ring (Green HNBR)	 21-84727 (5 per) No. 8 Springlock Garter Spring	 21-84728 (5 per) No. 8 Springlock Garter Spring	 21-84729 (5 per) No. 10 Springlock Garter Spring	 21-84730 (5 per) No. 12 Springlock Garter Spring

O-RINGS & GASKETS

IMPORTS

KITS

**21-24775
JAGUAR SERVICE O-RING
ASSORTMENT KIT** →

 40-02509 Expansion Valve Equalizer O-Ring Green HNBR	 40-02510 PRV Switch O-Ring Green HNBR	 40-02559 Orifice Tube O-Ring Green HNBR	 40-03501 #6 Standard Hose Fitting, Drier, TXV O-Ring Green HNBR	 40-03514 Cycling Pressure Switch O-Ring Green HNBR	 40-03502 #8 Standard Hose Fitting, Drier, TXV O-Ring Green HNBR
 40-03503 #10 Standard Hose Fitting, Drier, TXV O-Ring Green HNBR	 40-03504 #12 Standard Hose Fitting, Drier, TXV O-Ring Green HNBR	 40-02523 Suction Line O-Ring	 40-02529 GM A6 Service Port O-Ring Green HNBR	 40-02531 GM R4 Service Port O-Ring Green HNBR	 40-02564 Evaporator Pressure Valve Oil Bleed O-Ring Green HNBR
 21-84760 GM Compressor 5/8" I.D. Thick Sealing Washer (Neoprene)	 21-84761 GM Compressor 5/8" I.D. Thin Sealing Washer (Neoprene)	 21-84762 GM Compressor 3/4" I.D. Thin Sealing Washer (Neoprene)	 21-84763 GM Aluminum Short Pilot for 5/8" I.D. Thick Sealing Washer	 21-26067 York Flange Lathe Cut Seal (Blue Neoprene)	 21-26051 York Rotolock Teflon Seal

← **21-24777
SUZUKI SERVICE O-RING
KIT**

 40-02512 7mm Hose Fitting, Drier, Expansion Valve O-Ring (HNBR Green)	 40-02503 Equalizer Valve O-Ring (HNBR Green)	 40-03501 #5 Standard Hose Fitting, Drier, Expansion Valve O-Ring (HNBR Green)	 40-03502 #8 Standard Hose Fitting, Drier, Expansion Valve O-Ring (HNBR Green)
 40-03503 #10 Standard Hose Fitting, Condenser O-Ring (HNBR Green)	 40-02585 Nippondenso 10PC6E Compressor Inner Manifold (Neoprene)	 40-03504 #12 Standard Hose Fitting, Condenser O-Ring (HNBR Green)	 40-02612 16mm Drier, Fitting O-Ring (HNBR Green)



















**21-24778
TOYOTA / LEXUS SERVICE
O-RING ASSORTMENT KIT** →

 40-02512 7MM Metric Hose, Drier, TXV O-Ring (Green HNBR)	 40-02509 TXV, Equalizer O-Ring (Green HNBR)	 40-02562 14MM Hose Fitting O-Ring (Blue Neoprene)	 40-03503 No. 10 Hose Fitting, Compressor Manifold O-Ring (Green HNBR)	 40-02523 15MM I.D. Compressor Block O-Ring (Green HNBR)	 40-02542 Nippondenso 6P / 6E / 10P Compressor O-Ring (Green HNBR)
 40-02559 6.6MM Hose Fitting O-Ring (Green HNBR)	 40-03501 No. 6 Hose Fitting, Drier, TXV O-Ring (Green HNBR)	 40-02585 Nippondenso 10PO8E Compressor Inner Manifold O-Ring (Blue Neoprene)	 40-03504 No. 12 Hose Fitting, Evaporator O-Ring (Green HNBR)	 40-02529 Nippondenso 10PA Compressor O-Ring (Green HNBR)	 40-02560 13MM Block TXV O-Ring (Blue Neoprene)
 40-02582 11MM Hose Fitting O-Ring (Blue Neoprene)	 40-03502 No. 8 Hose Fitting O-Ring (Green HNBR)				

O-RINGS & GASKETS

IMPORTS

KITS

 40-02512 Metric Orifice Tube O-Ring OEM #15233387-9 (Yellow HNBR)	 40-02509 Equalizer Line O-Ring (Green HNBR)	 40-02502 No. 6 Hose Fitting, Expansion Valve, Drier O-Ring OEM #3522598-7, 3557459-0 (Yellow HNBR)	 40-02514 Cycling / Pressure Switch, FRV O-Ring OEM #3522598-6, 3737501-3 (Yellow HNBR)	 40-02503 No. 8 Hose Fitting, Expansion Valve O-Ring OEM #3522591-0, 3537503-9 (Yellow HNBR)	 40-02504 No. 10 Hose Fitting O-Ring OEM #3522590-3, 3337607-0 (Yellow HNBR)
 40-03503 Accumulator No. 10 Springlock O-Ring (Green HNBR)	 40-02507 No. 12 Hose, Accumulator, Evaporator O-Ring OEM #3522591-0, 333752-1 (Yellow HNBR)	 40-02559 Orifices Tube Standard Size O-Ring (Green HNBR)	 40-02529 GM A6 Compressor Port O-Ring (Green HNBR)	 40-02531 GM R4 Compressor Port O-Ring (Green HNBR)	 21-26051 York Compressor Rotolock Teflon Seal
 21-26067 York Compressor Flange Lathe Cut Seal (Blue Neoprene)	 21-84729 No. 10 Springlock Spring	 21-84760 GM Compressor 5/8" I.D. Thick Sealing Washer (Neoprene)	 21-84761 GM Compressor 5/8" I.D. Thin Sealing Washer (Neoprene)	 21-84762 GM Compressor 3/4" I.D. Thin Sealing Washer (Neoprene)	 21-84763 GM Aluminum Short Picot For 5/8" Thick Sealing Washer

21-24779
VOLVO MASTER SERVICE
O-RING ASSORTMENT
KIT

21-24780 G
BASIC IMPORT
METRIC O-RING
ASSORTMENT
KIT

40-02512 Toyota #5 / Import 7MM Hose Fitting, TXV, Filter Drier O-Ring	40-02602 Mazda / Ford Metric Cycling Switch, Import Switch 8MM O-Ring	40-02559 Acura / Mazda / Toyota GM Import Green Orifice Tube, Hose Fitting, Switch O-Ring	40-02673 Ford / Chrysler / Import 9MM Metric Switch, #8 Hose Fitting, Springlock O-Ring
40-02675 Ford / Mitsubishi / Hyundai / Mazda / Nissan #6 Metric Springlock, Hose Fitting O-Ring	40-02658 Ford / Mitsubishi / Hyundai / Mazda / Nissan #10 Metric Springlock, Hose Fitting O-Ring	40-02661 Ford / Mitsubishi / Hyundai / Mazda / Nissan #12 Metric Springlock, Hose Fitting O-Ring	40-02675 Mercedes / Porsche / Import Service Fitting O-Ring
40-02609 Mercedes / Porsche / Import 14MM Service O-Ring	40-02692 Porsche 7MM Service O-Ring	40-02694 Porsche / Mercedes 9MM Service O-Ring	40-02691 Porsche / Mercedes 17MM Service O-Ring

O-RINGS & GASKETS

IMPORTS

LATHE CUT SEALS

21-26063
SHELL
SEAL
6P127/148

21-26064
SHELL SEAL
6P134

21-26066
FRONT / REAR
SHELL FOR 6P134

21-26065
SUCTION / DISC
10PA17/10PA20
TOYOTA 10PA15C

21-26090N
INNER MANIFOLD SEAL
FOR TV12/14

21-26087N
INNER MANIFOLD
SEAL FOR 10P08E

21-26089N
INNER MANIFOLD FOR
10P13/15

21-26076
MANIFOLD SEAL
MERCEDES 10PA15C

21-26051

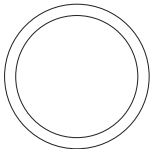

YORK TEFLON
ROTOLOCK SEAL

21-26067

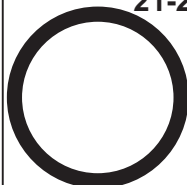



YORK SERVICE VALVE SEAL

O-RINGS & GASKETS

IMPORTS

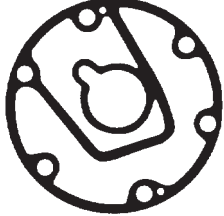
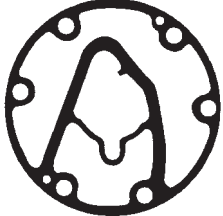
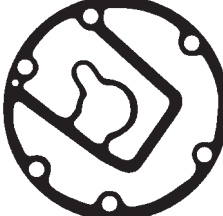
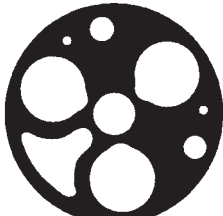
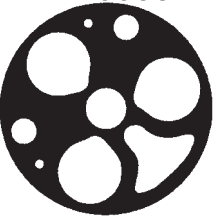
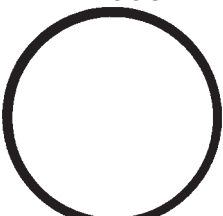
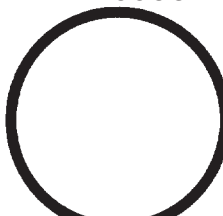

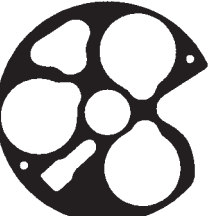
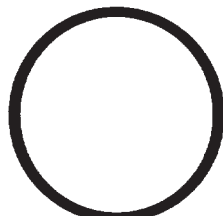
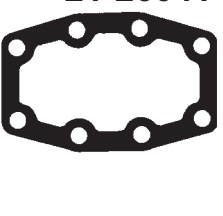
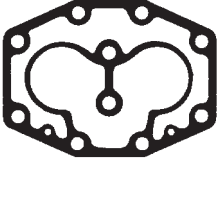
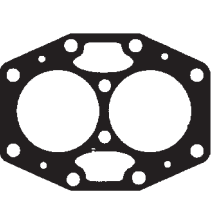
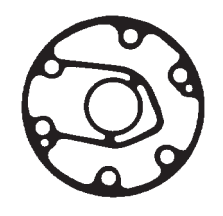
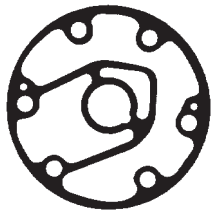
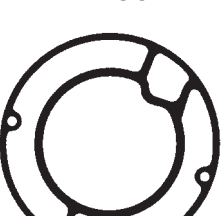
FIBER GASKETS

<p>21-26024</p>  <p>FIBER GASKET 6E-171A HEAD</p>	<p>21-26030</p>  <p>GASKET 6P-127 / 148</p>	<p>21-26031</p>  <p>GASKET 6P-134 HEAD</p>	<p>21-26032</p>  <p>HITACHI MJ-110/123 VALVE PLATE</p>
<p>21-26033</p>  <p>HITACHI MJ VALVE PLATE</p>	<p>21-26034</p>  <p>HITACHI MJ110/123/167 FRONT CASE</p>	<p>21-26035</p>  <p>HITACHI MJS-30 FRONT CASE</p>	<p>21-26036</p>  <p>HITACHI SWP-123/167 FRONT HEAD</p>
<p>21-26037</p>  <p>HITACHI SWP-123/167 REAR HEAD</p>	<p>21-26038</p>  <p>HITACHI SWP-123/167 VALVE PLATE</p>	<p>21-26039</p>  <p>HITACHI SWP-123/167 FRONT CASE</p>	<p>21-26041</p>  <p>HITACHI SWP CROSSOVER PLATE</p>
<p>21-26050</p>  <p>GASKET FOR 2C-90/90C HEAD</p>	<p>21-26073</p>  <p>GASKET 2C90C VALVE PLATE</p>	<p>21-26074</p>  <p>GASKET 6P127A FRONT HEAD</p>	<p>21-26075</p>  <p>GASKET 6P127A REAR HEAD</p>
<p>21-26077</p>  <p>GASKET FOR 10PA17C</p>	<p>ALL FIBER GASKETS ARE NON-ASBESTOS</p>		





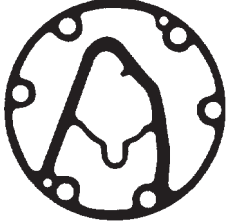
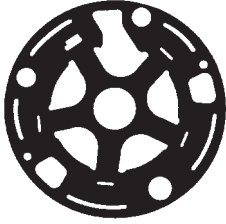
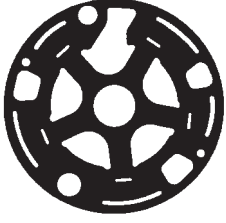

O-RINGS & GASKETS

IMPORTS

METAL GASKETS



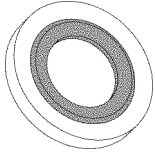
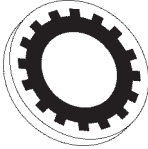
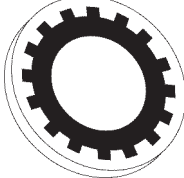







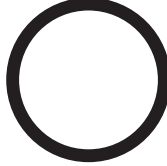

<p>21-84619</p>  <p>GASKET FOR 6P127 / 148 HEAD</p>	<p>21-84621</p>  <p>HEAD GASKET FOR 10P13 / 10P15</p>	<p>21-84622</p>  <p>REAR HEAD GASKET FOR 10P13 / 10P15</p>	<p>21-84645</p>  <p>FRONT HEAD GASKET FOR 10P08E</p>
<p>21-84646</p>  <p>REAR HEAD GASKET FOR 10P08E</p>			

Miscellaneous Items

<p>21-84727</p>  <p>#6 Springlock Garter</p>	<p>21-84728</p>  <p>#8 Springlock Garter</p>	<p>21-84729</p>  <p>#10 Springlock Garter</p>	<p>21-84730</p>  <p>#12 Springlock Garter</p>	
<p>21-84760</p>  <p>5/8" THICK SEALING WASHER</p>	<p>21-84761</p>  <p>5/8" THIN SEALING WASHER</p>	<p>21-84762</p>  <p>3/4" THIN SEALING WASHER</p>	<p>21-84763</p>  <p>SEALING WASHER INSERT</p>	

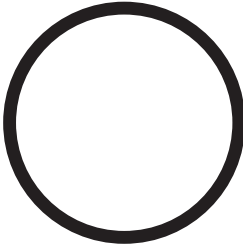
O-RINGS & GASKETS

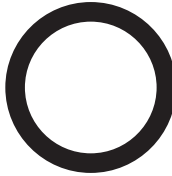
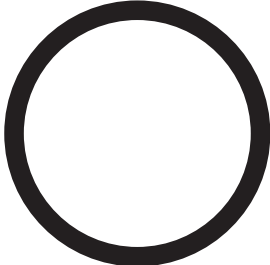
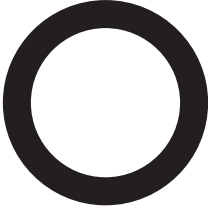
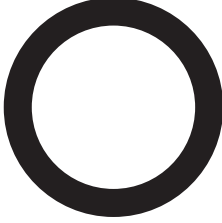
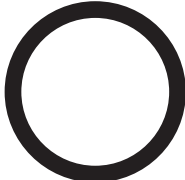
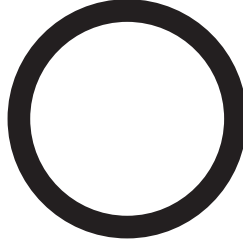
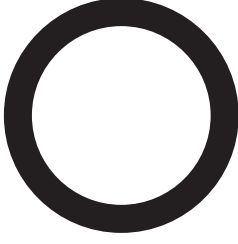
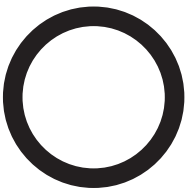
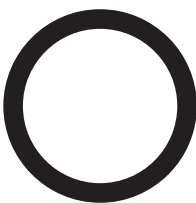
IMPORTS

<p>40-03501</p>  <p>40-02502 #6 HOSE FITTING</p>	<p>40-03502</p>  <p>40-02503 #8 HOSE FITTING</p>	<p>40-03503</p>  <p>40-02504 #10 HOSE FITTING</p>	<p>40-03504</p>  <p>40-02507 #12 HOSE FITTING</p>	<p>40-02509</p>  <p>EQUALIZER VALVE</p>
<p>40-02510</p>  <p>NISSAN 92477-N8200</p>	<p>40-02512</p>  <p>MAZDA / MITSUBISHI / VOLVO</p>	<p>40-02514</p>  <p>VOLVO CYCLING SWITCH 3522598-6</p>	<p>40-02515</p>  <p>MITSUBISHI FX105</p>	<p>40-02516</p>  <p>MATSUSHITA / MITSUBISHI / NISSAN</p>
<p>40-02518</p>  <p>NISSAN COMPRESSOR</p>	<p>40-02522</p>  <p>MITSUBISHI / NIHON</p>	<p>40-02523</p>  <p>HITACHI / KEIHIN/ MITSUBISHI / NIHON / BEHR</p>	<p>40-02524</p>  <p>NIHON</p>	<p>40-02526</p>  <p>NIHON COMPRESSOR</p>
<p>40-02529</p>  <p>NISSAN / SAAB/SEIKO SEIKI</p>	<p>40-02531</p>  <p>VOLVO R-4 SERVICE PORT</p>	<p>40-02537</p>  <p>NIPPONDENSO SERVICE VALVE O-RING</p>	<p>40-02538</p>  <p>NIPPONDENSO LIP SEAL</p>	<p>40-02539</p>  <p>NIPPONDENSO SHAFT SEAL O-RING</p>
<p>40-02542</p>  <p>MATSUSHITA / MITSUBISHI / NIPPONDENSO</p>	<p>40-02543</p>  <p>MITSUBISHI / NIHON</p>	<p>40-02545</p> <p>SEE NEXT IMPORT O-RING PAGE FOR DRAWING</p> <p>NIPPONDENSO</p>	<p>40-02546</p>  <p>MAZDA / MITSUBISHI</p>	<p>40-02547</p> <p>SEE NEXT IMPORT O-RING PAGE FOR DRAWING</p> <p>NIPPONDENSO SHELL O-RING</p>

O-RINGS & GASKETS

IMPORTS

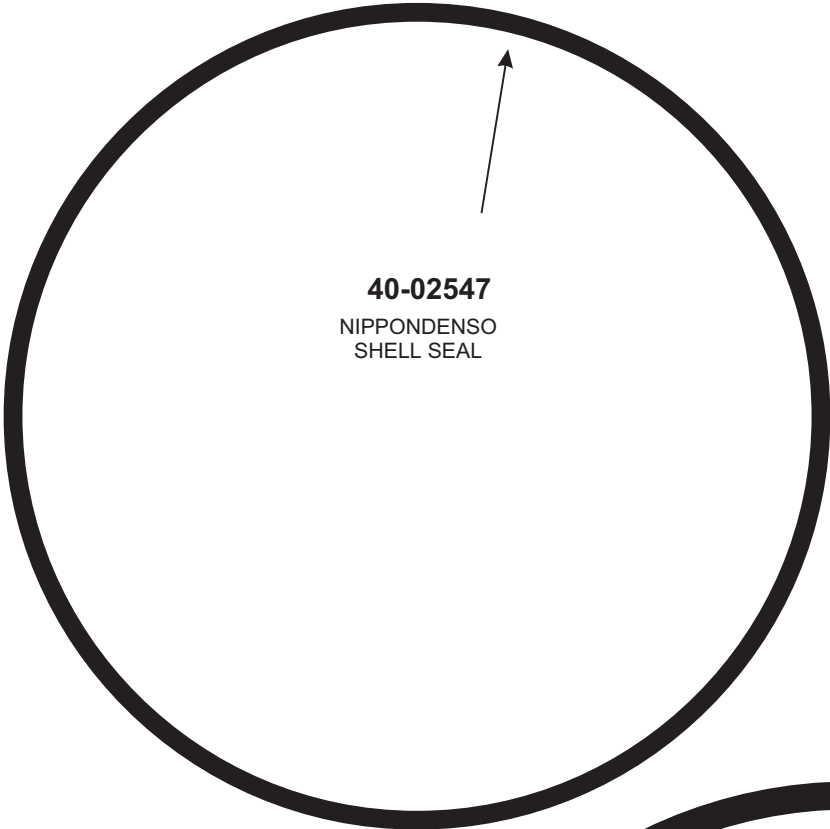



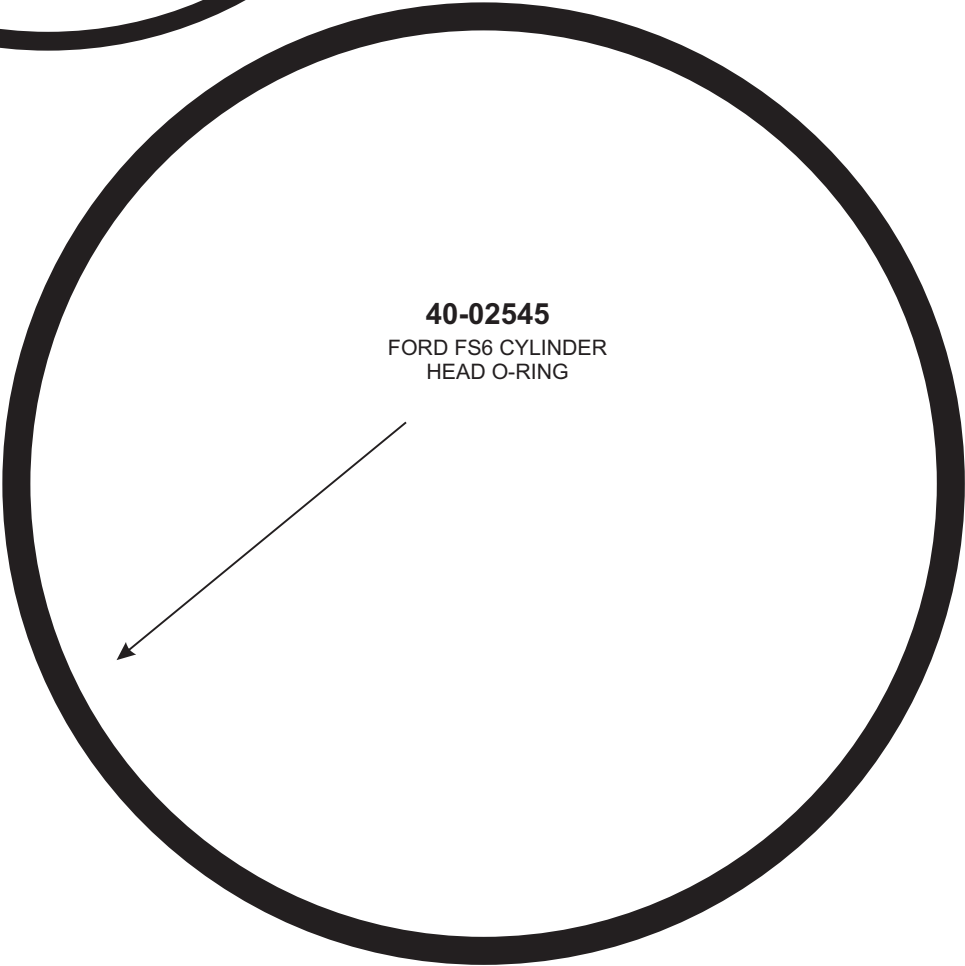







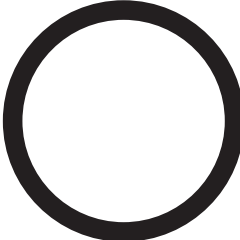





40-02547
NIPPONDENSO
SHELL SEAL

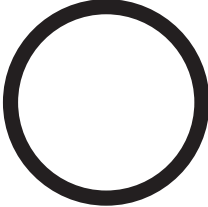

40-02545
FORD FS6 CYLINDER
HEAD O-RING

O-RINGS & GASKETS

IMPORTS

<p>40-02548</p> <p><i>SEE NEXT IMPORT O-RING PAGE FOR DRAWING</i></p> <p>HITACHI / NIPPONDENSO</p>	<p>40-02549</p> <p><i>SEE NEXT IMPORT O-RING PAGE FOR DRAWING</i></p> <p>NIPPONDENSO 6E171 SHELL O-RING</p>	<p>40-02550</p> <p><i>SEE NEXT IMPORT O-RING PAGE FOR DRAWING</i></p> <p>MITSUBISHI / NIPPONDENSO 3522598-6</p>	<p>40-02551</p>  <p>KEIHIN / NIHON</p>	<p>40-02552</p> <p><i>SEE NEXT IMPORT O-RING PAGE FOR DRAWING</i></p> <p>NIHON</p>
<p>40-02553</p> <p><i>SEE NEXT IMPORT O-RING PAGE FOR DRAWING</i></p> <p>BEHR BOSCH</p>	<p>40-02558</p>  <p>HITACHI / MATSUSHITA</p>	<p>40-02559</p>  <p>MAZDA / TOYOTA CONTROL VALVE O-RING</p>	<p>40-02560</p>  <p>HITACHI / MITSUBISHI / NISSAN</p>	<p>40-02561</p> <p>NIPPONDENSO FRONT SEAL O-RING</p> 
<p>40-02562</p>  <p>NIPPONDENSO / TOYOTA</p>	<p>40-02563</p> <p><i>SEE NEXT IMPORT O-RING PAGE FOR DRAWING</i></p> <p>NIPPONDENSO SHELL O-RING</p>	<p>40-02564</p>  <p>NISSAN EXP VALVE O-RING</p>	<p>40-02565</p>  <p>HITACHI / NISSAN</p>	<p>40-02566</p> <p>NIPPONDENSO VALVE PLATE SEAL O-RING</p> 
<p>40-02567</p> <p><i>SEE NEXT IMPORT O-RING PAGE FOR DRAWING</i></p> <p>NIPPONDENSO SHELL O-RING</p>	<p>40-02568</p> <p>NIHON / NIPPONDENSO</p> 	<p>40-02569</p>  <p>NIPPONDENSO HEAD O-RING</p>	<p>40-02570</p> <p><i>SEE NEXT IMPORT O-RING PAGE FOR DRAWING</i></p> <p>NIPPONDENSO CASE O-RING</p>	<p>40-02572</p> <p>NIPPONDENSO SEAL PLATE O-RING</p> 
<p>40-02580</p>  <p>HITACHI PICKUP TUBE O-RING</p>	<p>40-02581</p>  <p>HITACHI / MAZDA</p>	<p>40-02582</p>  <p>HITACHI / TOYOTA</p>	<p>40-02583</p>  <p>HITACHI CROSSOVER O-RING</p>	<p>40-02584</p>  <p>HITACHI / MAZDA</p>





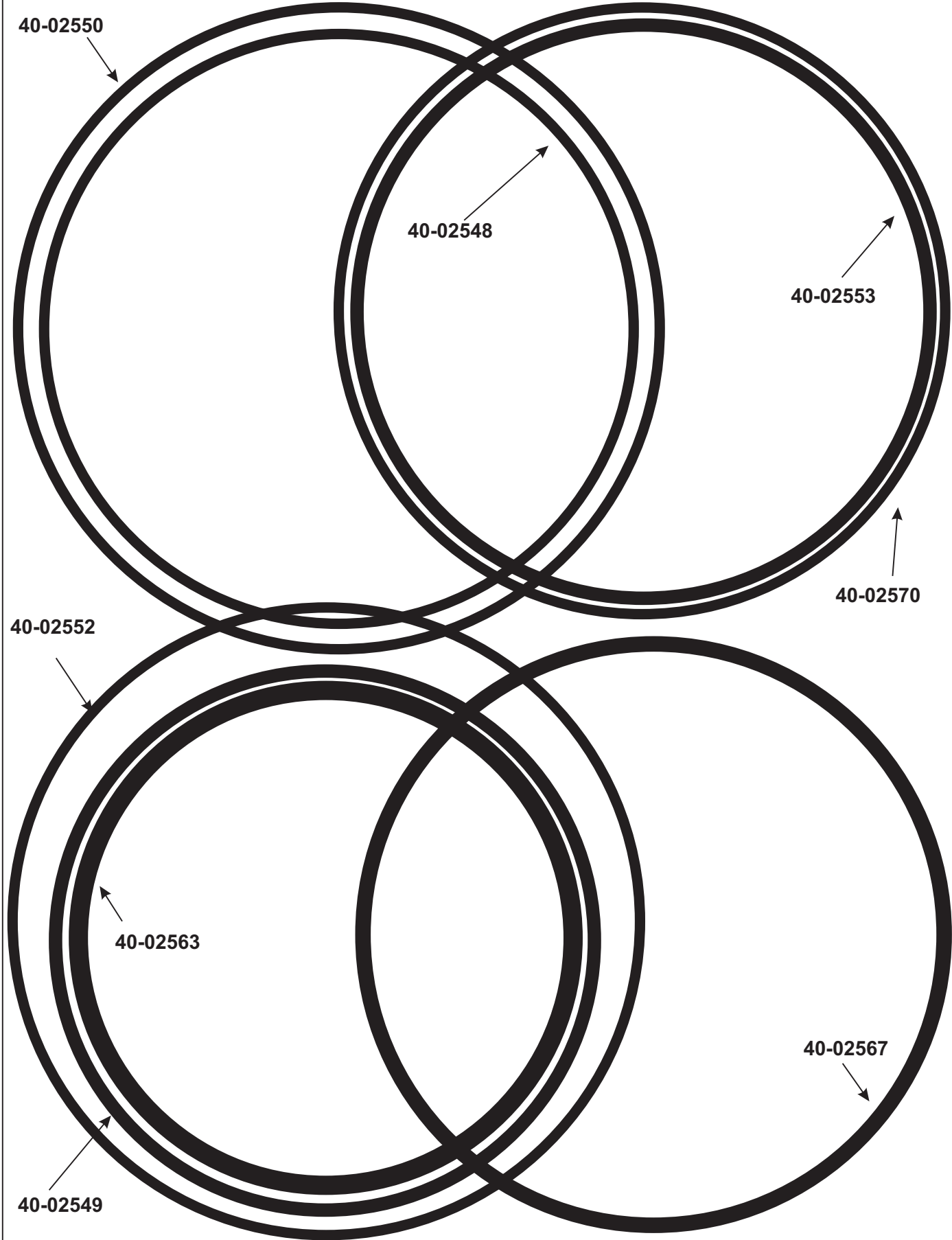

O-RINGS & GASKETS

IMPORTS

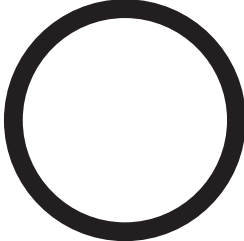
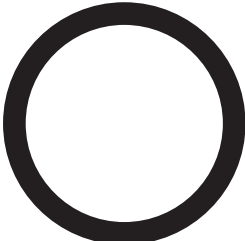
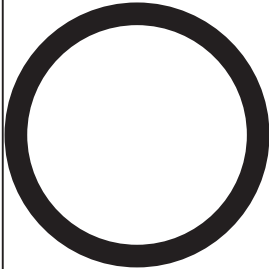
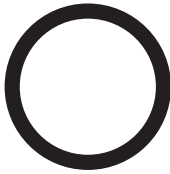
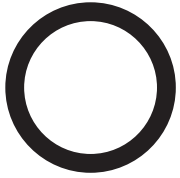
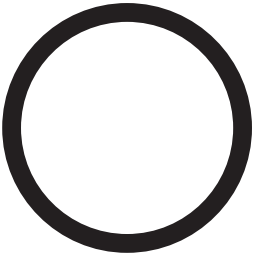

O-RINGS & GASKETS

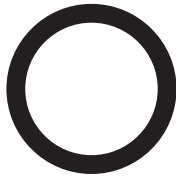
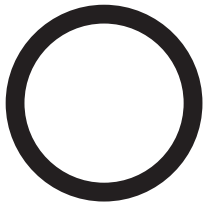
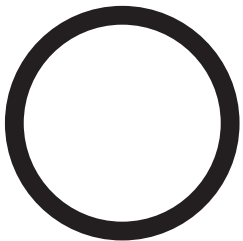
IMPORTS

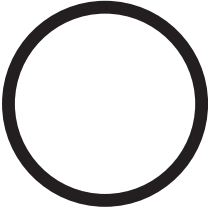
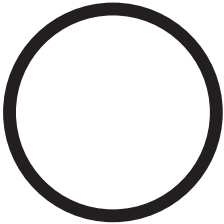
<p>40-02585</p>  <p>HITACHI SERVICE VALVE O-RING</p>	<p>40-02586</p>  <p>HITACHI SEAL HEAD O-RING</p>	<p>40-02587</p>  <p>HITACHI SEAL SEAT O-RING</p>	<p>40-02588</p>  <p>HITACHI SHAFT SEAL O-RING</p>	<p>40-02589</p> <p><i>SEE NEXT IMPORT O-RING PAGE FOR DRAWING</i></p> <p>HITACHI INNER VALVE PLATE O-RING</p>
<p>40-02590</p> <p><i>SEE NEXT IMPORT O-RING PAGE FOR DRAWING</i></p> <p>HITACHI INNER VALVE PLATE O-RING</p>	<p>40-02591</p> <p><i>SEE NEXT IMPORT O-RING PAGE FOR DRAWING</i></p> <p>HITACHI VALVE PLATE O-RING</p>	<p>40-02592</p> <p><i>SEE NEXT IMPORT O-RING PAGE FOR DRAWING</i></p> <p>HITACHI / NIHON</p>	<p>40-02593</p> <p><i>SEE NEXT IMPORT O-RING PAGE FOR DRAWING</i></p> <p>MIS. IMPORT APPLICATION</p>	<p>40-02594</p> <p><i>SEE NEXT IMPORT O-RING PAGE FOR DRAWING</i></p> <p>HITACHI REAR CASE O-RING</p>
<p>40-02595</p> <p><i>SEE NEXT IMPORT O-RING PAGE FOR DRAWING</i></p> <p>HITACHI REAR SHELL O-RING</p>	<p>40-02596</p>  <p>HITACHI SHAFT SEAL</p>	<p>40-02597</p>  <p>KEIHIN SUCTION FLANGE O-RING</p>	<p>40-02598</p> <p><i>SEE NEXT IMPORT O-RING PAGE FOR DRAWING</i></p> <p>KEIHIN HEAD SEAL O-RING</p>	<p>40-02599</p>  <p>NIHON SHAFT SEAL HEAD</p>
<p>40-02600</p>  <p>NIHON SHAFT SEAL SEAT O-RING</p>	<p>40-02601</p>  <p>NIHON HEAD PLATE SEAL O-RING</p>	<p>40-02602</p>  <p>8MM HOSE O-RING</p>	<p>40-02603</p>  <p>SELTEC SERVICE PORT O-RING</p>	<p>40-02605</p>  <p>SELTEC SERVICE PORT O-RING</p>
<p>40-02606</p>  <p>NIHON LARGE SEAL SEAT O-RING</p>	<p>40-02609</p>  <p>NIPPONDENSO BLOCK MANIFOLD O-RING</p>	<p>40-02612</p>  <p>MITSUBISHI / NISSAN</p>	<p>40-02620</p>  <p>NIPPONDENSO HEAD O-RING</p>	<p>40-02621</p>  <p>VIR POA O-RING</p>

O-RINGS & GASKETS

IMPORTS

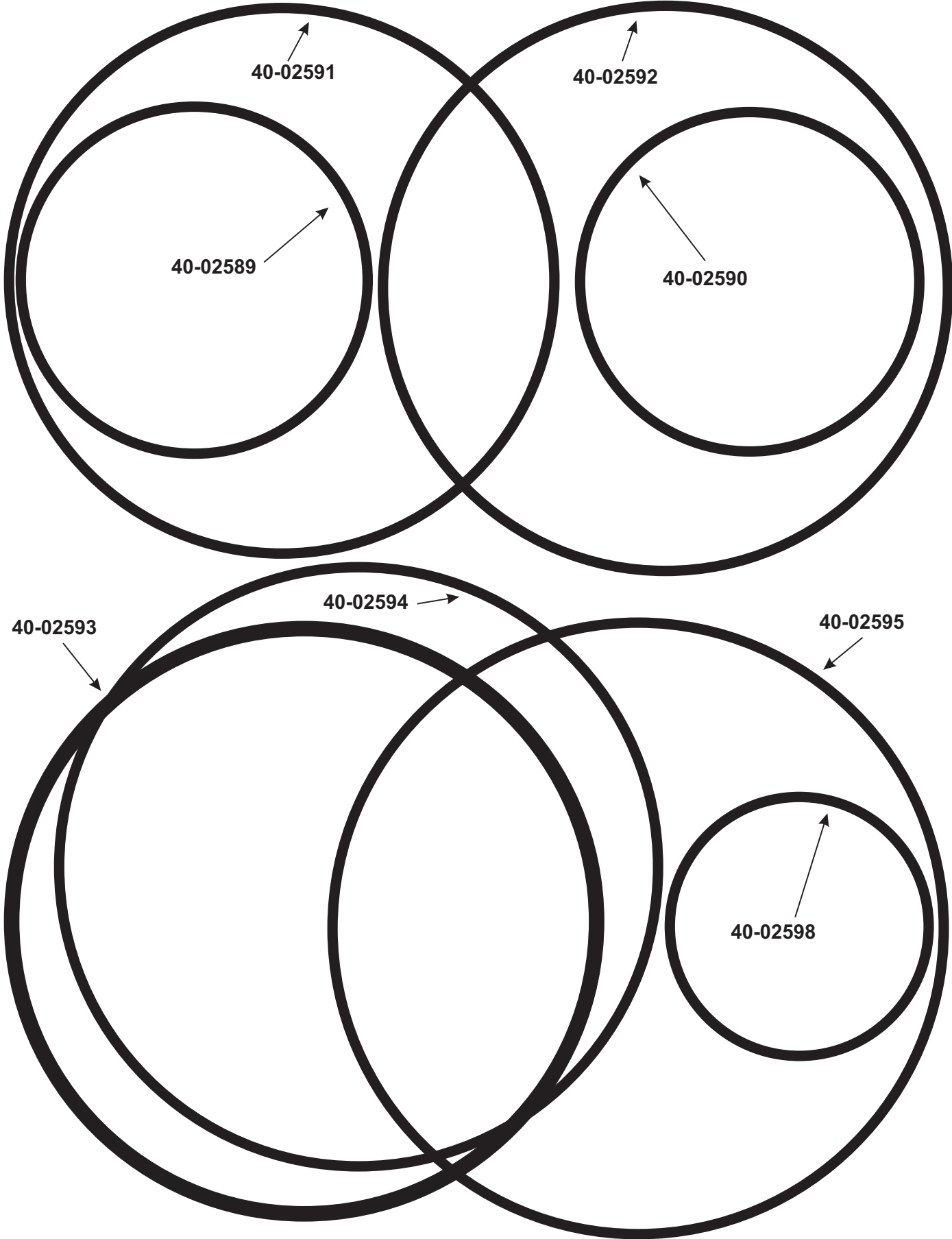

O-RINGS & GASKETS

IMPORTS

40-02623

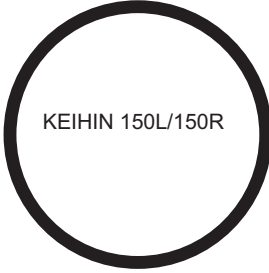

KEIHIN 150L/150R

40-02624



NIHON DKV14C

40-02625



KEIHIN 150L / 150R
HEAD

40-02628

NIHON DKV14C OUTER
SHELL O-RING

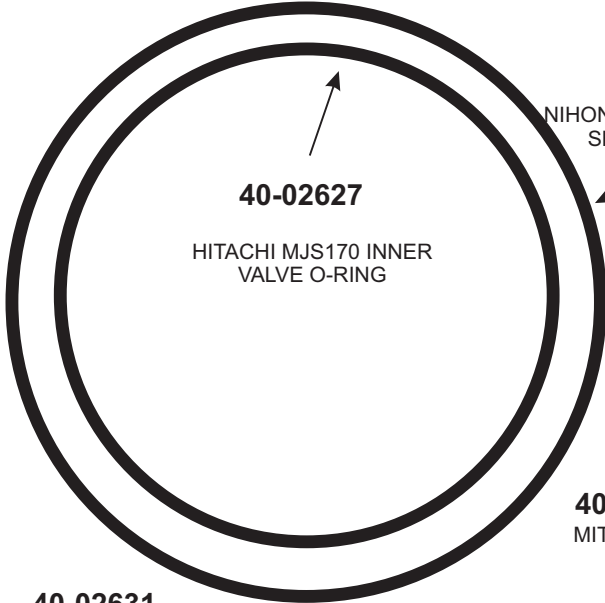

40-02627

HITACHI MJS170 INNER
VALVE O-RING

40-02629

MATSUSHITA NL1300AE4
FRONT PLATE O-RING

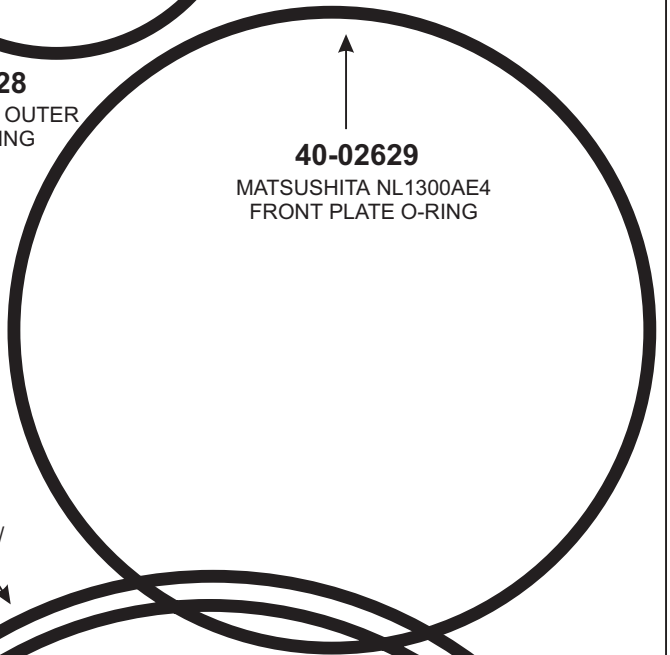

40-02633

MITSUBISHI /
NIHON

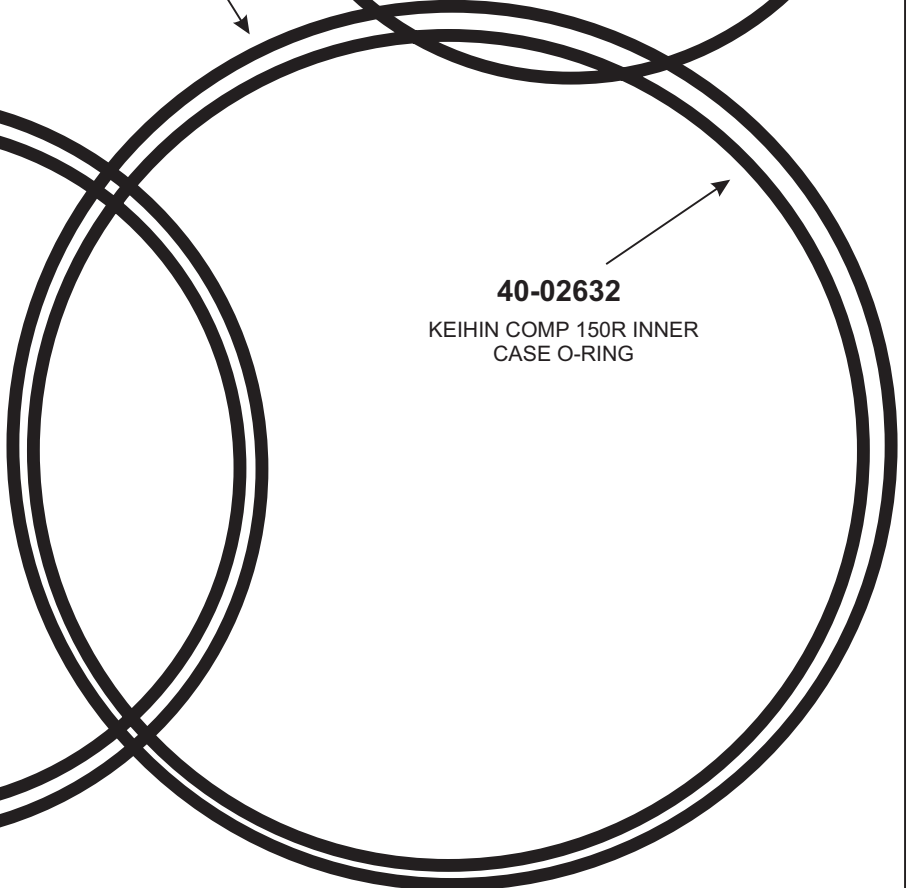

40-02632

KEIHIN COMP 150R INNER
CASE O-RING

40-02631

KEIHIN INNER CASE
O-RING

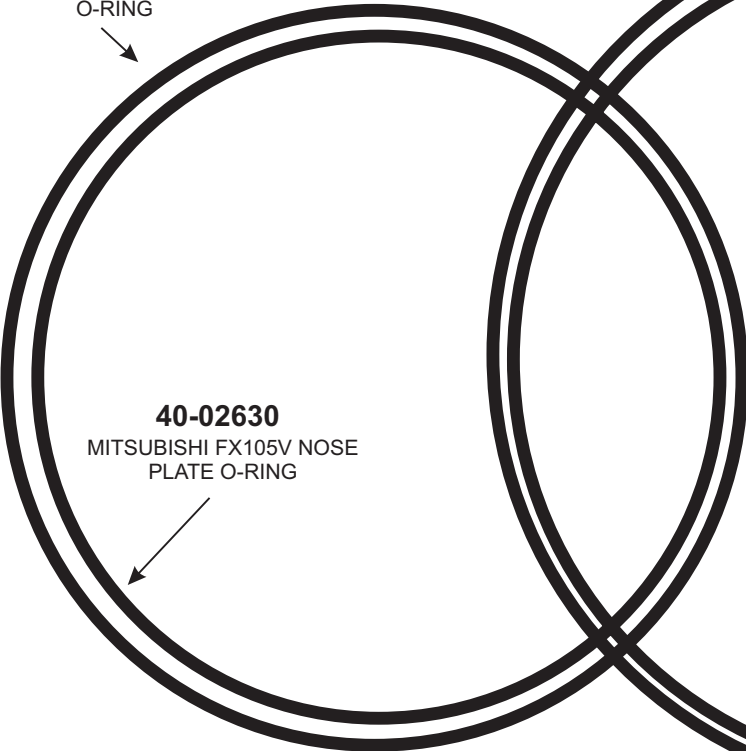

40-02630

MITSUBISHI FX105V NOSE
PLATE O-RING

O-RINGS & GASKETS

IMPORTS



40-02643
NIHON DKV14C CASE
O-RING

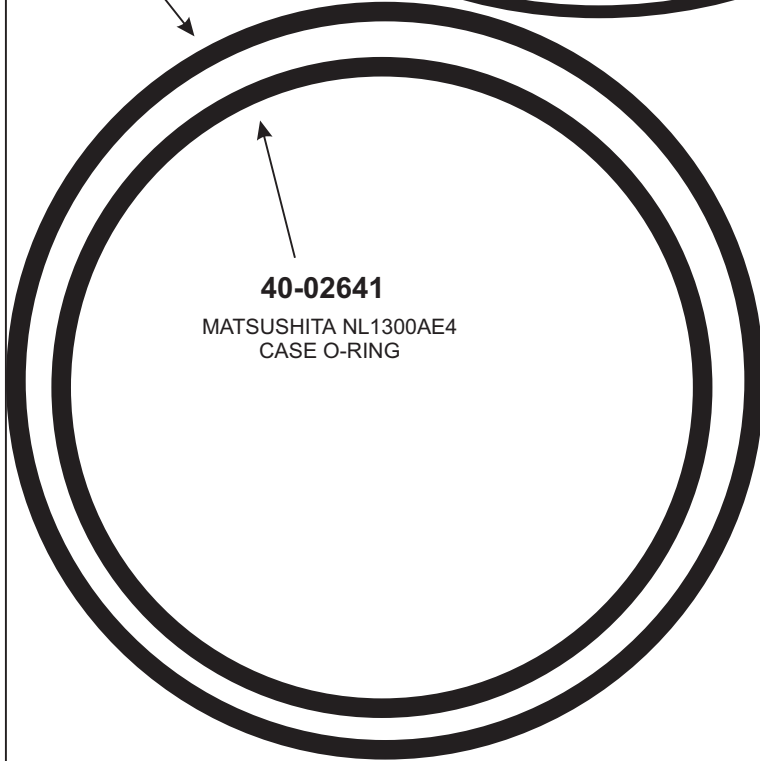

<p>40-02645 BEHR BOSCH O-RING</p>	<p>40-02650</p> <p>HITACHI / TOYOTA</p>
<p>40-02658</p> <p>#10 METRIC O-RING</p>	<p>40-02661</p> <p>#12 METRIC O-RING</p>

O-RINGS & GASKETS

IMPORTS



40-02663
NIPPONDENSO SPEED
SENSOR O-RING



40-02664
NIHON NOSE PLATE CASE
O-RING



40-02665
HITACHI HEAD O-RING

40-02667
NIPPONDENSO CENTER
SHELL O-RING

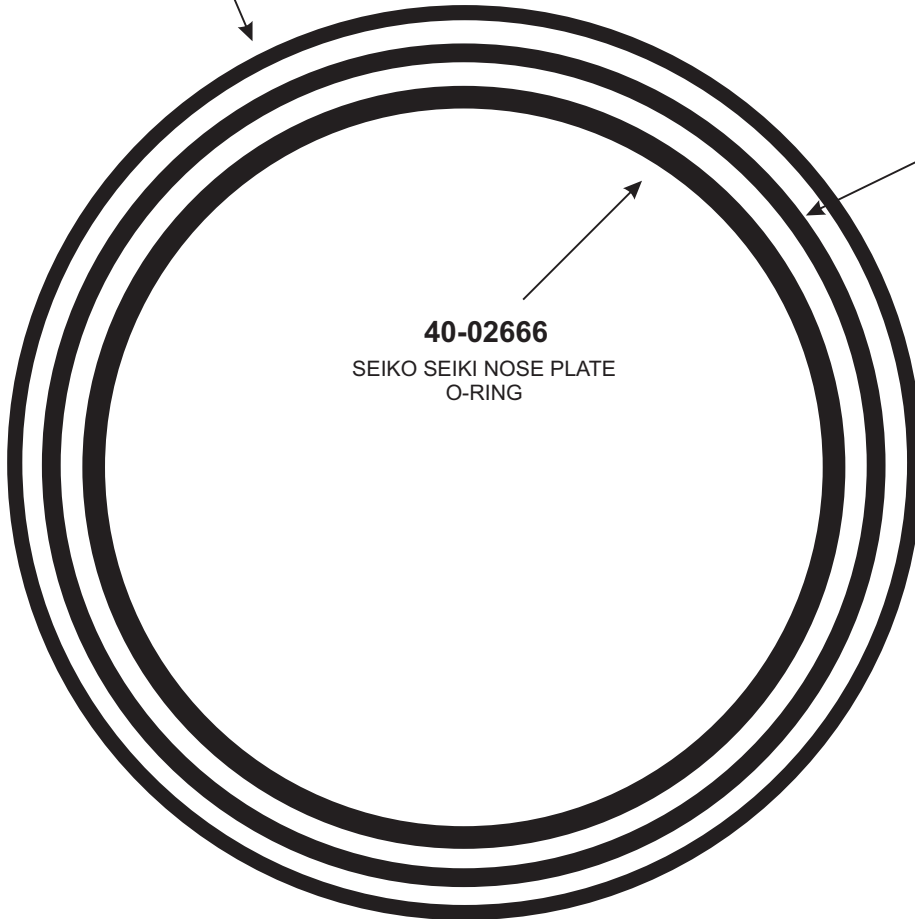

40-02668
NIPPONDENSO SHELL
O-RING



40-02666
SEIKO SEIKI NOSE PLATE
O-RING



40-02669
NIPPONDENSO
SHAFT SEAL O-RING







40-02673

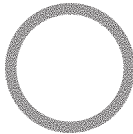

9MM METRIC SWITCH
PORT O-RING

O-RINGS & GASKETS

IMPORTS

<p>40-02675</p>  <p>MITSUBISHI HYUNDAI / MAZDA #6 METRIC</p>	<p>40-02685</p>  <p>MITSUBISHI FX105</p>	 <p>40-02686 MITSUBISHI FX 80</p>
<p>40-02691</p>  <p>PORSCHE / MERCEDES 17MM O-RING</p>	<p>40-02692</p>  <p>PORSCHE 7MM O-RING</p>	
<p>40-02693</p>  <p>10MM METRIC O-RING</p>	<p>40-02694</p>  <p>PORSCHE / MERCEDES 9MM O-RING</p>	
		 <p>40-02687 MITSUBISHI FX80</p>

O-RINGS & GASKETS

IMPORTS

Assortment Kits

21-24655	VOLVO BLUE ASSORTMENT KIT
21-24705	INFINITI, NISSAN SERVICE O-RING ASSORTMENT KIT
21-24707	VOLVO RETRO FIT O-RING ASSORTMENT KIT
21-24708	METRIC / IMPORT O-RING ASSORTMENT KIT
21-24709	METRIC / STANDARD O-RING ASSORTMENT KIT
21-24764	AUDI / VOLKSWAGEN SERVICE O-RING ASSORTMENT KIT
21-24765	BMW SERVICE ASSORTMENT KIT
21-24766	GEO SERVICE ASSORTMENT KIT
21-24767	HONDA / ACURA SERVICE O-RING ASSORTMENT KIT
21-24768	HYUNDAI SERVICE O-RING ASSORTMENT KIT
21-24769 G	MERCEDES SERVICE ASSORTMENT KIT
21-24770 G	MINI SERVICE ASSORTMENT KIT
21-24771 G	PORSCHE O-RING ASSORTMENT KIT
21-24772 G	SAAB SERVICE ASSORTMENT KIT
21-24773	SUBARU SERVICE ASSORTMENT KIT
21-24774	ISUZU SERVICE ASSORTMENT KIT
21-24775	JAGUAR SERVICE O-RING ASSORTMENT KIT
21-24776 G	MAZDA SERVICE ASSORTMENT KIT
21-24777	SUZUKI SERVICE ASSORTMENT KIT
21-24778	TOYOTA / LEXUS SERVICE ASSORTMENT KIT
21-24779	VOLVO MASTER SERVICE ASSORTMENT KIT
21-24780 G	BASIC IMPORT METRIC O-RING ASSORTMENT KIT

Black R12 (only)	Black R12 /R134a	Blue R12 /R134a	Green R12 /R134a	Yellow R12 /R134a
---------------------	---------------------	--------------------	---------------------	----------------------

Lathe Cut Seals

21-26051				TEFLON ROTOLOCK SEAL
21-26063	21-26063 N	21-26063 B		SHELL SEAL 6P127 / 148
21-26064	21-26064 N	21-26064 B		SHELL SEAL 6P134
21-26065	21-26065 N	21-26065 B		SUCTION / DISCHARGE 10PA17/10PA20
21-26066	21-26066 N	21-26066 B		FRONT / REAR SHELL FOR 6P134
21-26067	21-26067 N	21-26067 B		YORK SERVICE VALVE SEAL
21-26076	21-26076 N	21-26076 B		MANIFOLD SEAL MERCEDES 10PA15C
21-26087	21-26087 N	21-26087 B		INNER MANIFOLD SEAL FOR 10P08E
21-26089	21-26089 N	21-26089 B		INNER MANIFOLD FOR 10P13 /15
21-26090	21-26090 N	21-26090 B		INNER MANIFOLD SEAL FOR TV12 /14

Fiber Gaskets

21-26024	GASKET 6E-171A HEAD
21-26030	GASKET 6P-127 / 148
21-26031	GASKET 6P-134 HEAD
21-26032	GASKET MJ-110 /123 VALVE PLATE
21-26033	GASKET HITACHI MJ VALVE PLATE
21-26034	GASKET HITACHI MJ110 / 123 / 167 FRONT CASE
21-26035	GASKET HITACHI MJS-30 FRONT CASE
21-26036	GASKET HITACHI SWP-123 / 167 FRONT HEAD
21-26037	GASKET HITACHI SWP-123 / 167 REAR HEAD
21-26038	GASKET HITACHI SWP-123 / 167 VALVE PLATE
21-26039	GASKET HITACHI SWP-12 / 167 FRONT CASE
21-26041	GASKET HITACHI SWP CROSSOVER PLATE
21-26050	GASKET 2C90 / 90C HEAD
21-26073	GASKET 2C90C VALVE PLATE
21-26074	GASKET P6127A FRONT HEAD
21-26075	GASKET 6P127A REAR HEAD
21-26077	GASKET 10PA17C

Metal Gaskets

21-84619	GASKET FOR 6P127 / 148 HEAD
21-84621	GASKET FOR 10P13 / 10P15
21-84622	GASKET REAR HEAD FOR 10P13 / 10P15
21-84645	GASKET HEAD FOR 10P08E
21-84646	GASKET HEAD FOR 10P08E

Miscellaneous Items

21-84727	#6 SPRINGLOCK GARTER
21-84728	#8 SPRINGLOCK GARTER
21-84729	#10 SPRINGLOCK GARTER
21-84730	#12 SPRINGLOCK GARTER
21-84760	5/8" THICK SEALING WASHER
21-84761	5/8" THICK SEALING WASHER
21-84762	3/4" THICK SEALING WASHER
21-84763	SEALING WASHER INSERT

O-RINGS & GASKETS

IMPORTS

Black R12 (only)	Black R12 /R134a	Blue R12 /R134a	Green R12 /R134a	Yellow R12 /R134a
---------------------	---------------------	--------------------	---------------------	----------------------

O-Rings

40-02502	40-02502 N	40-02502 B	40-03501	40-02502 Y	#6 Hose Fittings O-Ring
40-02503	40-02503 N	40-02503 B	40-03502	40-02503 Y	#8 Hose Fitting O-Ring
40-02504	40-02504 N	40-02504 B	40-03503	40-02504 Y	#10 Hose Fitting O-Ring
40-02507	40-02507 N	40-02507 B	40-03504	40-02507 Y	#12 Hose Fitting O-Ring
40-02509	40-02509 N	40-02509 B	40-02509 G		Capillary Tube O-Ring
40-02510	40-02510 N	40-02510 B	40-02510 G		Nissan Service O-Ring 92477-N8200
40-02512	40-02512 N	40-02512 B	40-02512 G		Mazda / Mitsubishi / Volvo Service O-Ring
40-02514	40-02514 N	40-02514 B	40-02514 G		Volvo Cycling Swtich O-Ring 3522598-6
40-02515	40-02515 N	40-02515 B	40-02515 G		Mitsubishi FX105
40-02516	40-02516 N	40-02516 B	40-02516 G		Matsushita / Mitsubishi / Nissan O-Ring
40-02518	40-02518 N	40-02518 B	40-02518 G		Nissan Compressor
40-02522	40-02522 N	40-02522 B	40-02522 G		Mitsubishi / Nihon Service O-Ring
40-02523	40-02523 N	40-02523 B	40-02523 G		Hitachi / Keihin / Mitsubishi / Nihon / Behr
40-02524	40-02524 N	40-02524 B	40-02524 G		Nihon Service O-Ring
40-02526	40-02526 N	40-02526 B	40-02526 G		Nihon Compressor O-Ring
40-02529	40-02529 N	40-02529 B	40-02529 G		Nissan / SAAB / Seiko Seiki O-Ring
40-02531	40-02531 N	40-02531 B	40-02531 G		Volvo R4 Service Valve O-Ring
40-02537	40-02537 N	40-02537 B	40-02537 G		Nippondenso Service Valve O-Ring
40-02538	40-02538 N	40-02538 B	40-02538 G		Nippondenso Lip Seal O-Ring
40-02539	40-02539 N	40-02539 B	40-02539 G		Nippondenso Shaft Seal O-Ring
40-02542	40-02542 N	40-02542 B	40-02542 G		Matsushita / Mitsubishi / Nippondenso O-Ring
40-02543	40-02543 N	40-02543 B	40-02543 G		Mitsubishi / Nihon O-Ring
40-02545	40-02545 N	40-02545 B	40-02545 G		Nippondenso O-Ring
40-02546	40-02546 N	40-02546 B	40-02546 G		Mazda / Mitsubishi O-Ring
40-02547	40-02547 N	40-02547 B	40-02547 G		Nippondenso Shell O-Ring
40-02548	40-02548 N	40-02548 B	40-02548 G		Hitachi / Nippondenso O-Ring
40-02549	40-02549 N	40-02549 B	40-02549 G		Nippondenso 6E171 Shell O-Ring
40-02550	40-02550 N	40-02550 B	40-02550 G		Mitsubishi / Nippondenso O-Ring
40-02551	40-02551 N	40-02551 B	40-02551 G		Keihin / Nihon O-Ring
40-02552	40-02552 N	40-02552 B	40-02552 G		Nihon O-Ring
40-02553	40-02553 N	40-02553 B	40-02553 G		Behr Bosch O-Ring
40-02558	40-02558 N	40-02558 B	40-02558 G		Hitachi / Matsushita O-Ring
40-02559	40-02559 N	40-02559 B	40-02559 G		Mazda / Toyota Control Valve O-Ring
40-02560	40-02560 N	40-02560 B	40-02560 G		Hitachi / Mitsubishi / Nissan O-Ring
40-02561	40-02561 N	40-02561 B	40-02561 G		Nippondenso Front Seal O-Ring
40-02562	40-02562 N	40-02562 B	40-02562 G		Nippondenso / Toyota O-Ring
40-02563	40-02563 N	40-02563 B	40-02563 G		Nippondenso Shell O-Ring
40-02564	40-02564 N	40-02564 B	40-02564 G		Nissan Exp Valve O-Ring
40-02565	40-02565 N	40-02565 B	40-02565 G		Hitachi / Nissan O-Ring
40-02566	40-02566 N	40-02566 B	40-02566 G		Nippondenso Valve Plate O-Ring
40-02567	40-02567 N	40-02567 B	40-02567 G		Nippondenso O-Ring
40-02568	40-02568 N	40-02568 B	40-02568 G		Nihon / Nippondenso O-Ring
40-02569	40-02569 N	40-02569 B	40-02569 G		Nippondenso Head O-Ring
40-02570	40-02570 N	40-02570 B	40-02570 G		Nippondenso Case O-Ring
40-02572	40-02572 N	40-02572 B	40-02572 G		Nippondenso Seal Plate O-Ring
40-02580	40-02580 N	40-02580 B	40-02580 G		Hitachi Pickup Tube O-Ring
40-02581	40-02581 N	40-02581 B	40-02581 G		Hitachi / Mazda O-Ring
40-02582	40-02582 N	40-02582 B	40-02582 G		Hitachi / Toyota O-Ring
40-02583	40-02583 N	40-02583 B	40-02583 G		Hitachi Crossover O-Ring
40-02584	40-02584 N	40-02584 B	40-02584 G		Hitachi / Mazda O-Ring
40-02585	40-02585 N	40-02585 B	40-02585 G		Hitachi Service Valve O-Ring
40-02586	40-02586 N	40-02586 B	40-02586 G		Hitachi Seal Head O-Ring
40-02587	40-02587 N	40-02587 B	40-02587 G		Hitachi Seal Seat O-Ring
40-02588	40-02588 N	40-02588 B	40-02588 G		Hitachi Shaft Seal O-Ring
40-02589	40-02589 N	40-02589 B	40-02589 G		Hitachi Inner Valve Plate O-Ring
40-02590	40-02590 N	40-02590 B	40-02590 G		Hitachi Inner Valve Plate O-Ring
40-02591	40-02591 N	40-02591 B	40-02591 G		Hitachi Valve Plate O-Ring
40-02592	40-02592 N	40-02592 B	40-02592 G		Hitachi / Nihon O-Ring
40-02593	40-02593 N	40-02593 B	40-02593 G		Mis. Import Application O-Ring
40-02594	40-02594 N	40-02594 B	40-02594 G		Hitachi Rear Case O-Ring
40-02595	40-02595 N	40-02595 B	40-02595 G		Hitachi Rear Shell O-Ring
40-02596	40-02596 N	40-02596 B	40-02596 G		Hitachi Shaft Seal O-Ring
40-02597	40-02597 N	40-02597 B	40-02597 G		Keihin Suction Flange O-Ring
40-02598	40-02598 N	40-02598 B	40-02598 G		Keihin Head Seal O-Ring
40-02599	40-02599 N	40-02599 B	40-02599 G		Nihon Shaft Seal O-Ring
40-02600	40-02600 N	40-02600 B	40-02600 G		Nihon Shaft Seal Seat O-Ring
40-02601	40-02601 N	40-02601 B	40-02601 G		Nihon Head Plate O-Ring

O-RINGS & GASKETS

IMPORTS

40-02602	40-02602 N	40-02602 B	40-02602 G	
Black R12 (only)	Black R12 /R134a	Blue R12 /R134a	Green R12 /R134a	Yellow R12 /R134a

8mm Hose O-Ring

O-Rings

40-02603	40-02603 N	40-02603 B	40-02603 G	Seltec Service O-Ring
40-02605	40-02605 N	40-02605 B	40-02605 G	Seltec Service O-Ring
40-02606	40-02606 N	40-02606 B	40-02606 G	Nihon Large Seal Seat O-Ring
40-02609	40-02609 N	40-02609 B	40-02609 G	Nippondenso Block Manifold O-Ring
40-02612	40-02612 N	40-02612 B	40-02612 G	Mitsubishi / Nissan O-Ring
40-02620	40-02620 N	40-02620 B	40-02620 G	Nippondenso Head O-Ring
40-02621	40-02621 N	40-02621 B	40-02621 G	Vir POA O-Ring
40-02623	40-02623 N	40-02623 B	40-02623 G	Keihin 150L / 150 R O-ring
40-02624	40-02624 N	40-02624 B	40-02624 G	Nihon DKV14C O-Ring
40-02625	40-02625 N	40-02625 B	40-02625 G	Keihin 150L / 150R Head O-Ring
40-02627	40-02627 N	40-02627 B	40-02627 G	Hitachi MJS170 Inner Valve O-Ring
40-02628	40-02628 N	40-02628 B	40-02628 G	Nihon DKV14C Outer Shell O-Ring
40-02629	40-02629 N	40-02629 B	40-02629 G	Matsushita NL1300AE4 Front Plate O-Ring
40-02630	40-02630 N	40-02630 B	40-02630 G	Mitsubishi FX105V Nose Plate O-Ring
40-02631	40-02631 N	40-02631 B	40-02631 G	Keihin Inner Case O-Ring
40-02632	40-02632 N	40-02632 B	40-02632 G	Keihin Compressor 150R Inner Case O-Ring
40-02633	40-02633 N	40-02633 B	40-02633 G	Mitsubishi / Nihon O-Ring
40-02634	40-02634 N	40-02634 B	40-02634 G	Keihin Model 150L Outer Case O-Ring
40-02639	40-02639 N	40-02639 B	40-02639 G	Seiko Seiki SS1700PSS Housing O-Ring
40-02641	40-02641 N	40-02641 B	40-02641 G	Matsushita NL1300AE4 Case O-Ring
40-02643	40-02643 N	40-02643 B	40-02643 G	Nihon DKV14C Case O-Ring
40-02644	40-02644 N	40-02644 B	40-02644 G	Nipp. Shaft Seal O-Ring
40-02645	40-02645 N	40-02645 B	40-02645 G	Behr Bosch O-Ring
40-02650	40-02650 N	40-02650 B	40-02650 G	Hitachi / Toyota
40-02658	40-02658 N	40-02658 B	40-02658 G	#10 Metric O-Ring
40-02661	40-02661 N	40-02661 B	40-02661 G	#12 Metric O-Ring
40-02663	40-02663 N	40-02663 B	40-02663 G	Nippondenso Speed Sensor O-Ring
40-02664	40-02664 N	40-02664 B	40-02664 G	Nihon Nose Plate Case O-Ring
40-02665	40-02665 N	40-02665 B	40-02665 G	Hitachi Head O-Ring
40-02666	40-02666 N	40-02666 B	40-02666 G	Seiko Seiki Nose Plate O-Ring
40-02667	40-02667 N	40-02667 B	40-02667 G	Nippondenso Center Shell O-Ring
40-02668	40-02668 N	40-02668 B	40-02668 G	Nippondenso Shell O-Ring
40-02669	40-02669 N	40-02669 B	40-02669 G	Nippondenso Shaft Seal O-Ring
40-02673	40-02673 N	40-02673 B	40-02673 G	9mm Metric Switch Port O-Ring
40-02675	40-02675 N	40-02675 B	40-02675 G	Mitsubishi / Hyundai / Mazda O-Ring
40-02685	40-02685 N	40-02685 B	40-02685 G	Mitsubishi FX105 O-Ring
40-02686	40-02686 N	40-02686 B	40-02686 G	Mitsubishi FX80 O-Ring
40-02687	40-02687 N	40-02687 B	40-02687 G	Mitsubishi FX80
40-02691	40-02691 N	40-02691 B	40-02691 G	Porsche / Mercedes 17mm O-Ring
40-02692	40-02692 N	40-02692 B	40-02692 G	Porsche 7mm O-Ring
40-02693	40-02693 N	40-02693 B	40-02693 G	10mm Metric O-Ring
40-02694	40-02694 N	40-02694 B	40-02694 G	Porsche / Mercedes 9mm O-Ring

O-RINGS & GASKETS

AFTERMARKET

UNICLA

UNIVERSAL

SANDEN





















DIESEL KIKI

SELTEC

YORK

























O-RINGS & GASKETS

AFTERMARKET

 40-02509-B Capillary	 40-02510-B Nissan #8 Hose Fitting	 40-02502-B #6 Standard	 40-02514-B Compressor Switch Port / Oil Plug /	 40-02503-B #8 Standard	 40-02504-B #10 Standard
 40-03504 #12 Ford Springlock	 40-02519-B #6 GM Captive	 40-03501 #6 Ford Springlock	 40-02558-B #10 GM Captive	 40-03502 #8 Ford Springlock	 40-03503 #10 Ford Springlock
 40-02529-B GM A6, DA6, HR6, V5, Ford-FS10, FX15, Nipp.	 40-02530-B GM "Oval" Service	 40-02520-B #8 GM Captive	 40-02532-B GM #10	 40-02522-B #12 GM Captive	 40-02528-B Chrysler Block
		 40-02531-B Chrysler Block Valve /		 40-02533-B GM #12	 40-02534-B GM #8

← **21-24710**
UNIVERSAL O-RING
ASSORTMENT KIT

21-24745 →
UNIVERSAL
COMPRESSOR SERVICE
PORT O-RING KIT

 40-02581 Metric O-Ring	 40-02582 Metric O-Ring	 40-02609 Metric O-Ring	 40-02565 Metric O-Ring	 40-02585 Metric O-Ring	 40-02603 Metric O-Ring
 40-02597 Metric O-Ring	 40-02605 Metric O-Ring	 40-02560 Standard O-Ring	 40-02522 Standard O-Ring	 40-02523 Standard O-Ring	 40-02523 Standard O-Ring
 40-02542 Standard O-Ring	 40-02542 R Red Oval O-Ring	 40-02542 RG Green Oval O-Ring	 40-02543 Standard O-Ring	 40-02529 Standard O-Ring	 40-02530 Blue Oval O-Ring
 40-02537 Standard O-Ring	 40-02531 Standard O-Ring	 40-02650 Standard O-Ring	 21-26067 Lathe Cut Seal	 21-26060 Lathe Cut Seal	 21-26051 Lathe Cut Seal

O-RINGS & GASKETS

AFTERMARKET

LATHE CUT SEALS



21-26059
YORK, TECUMSEH
COMPRESSOR TUBE-O
SERVICE VALVE SEAL

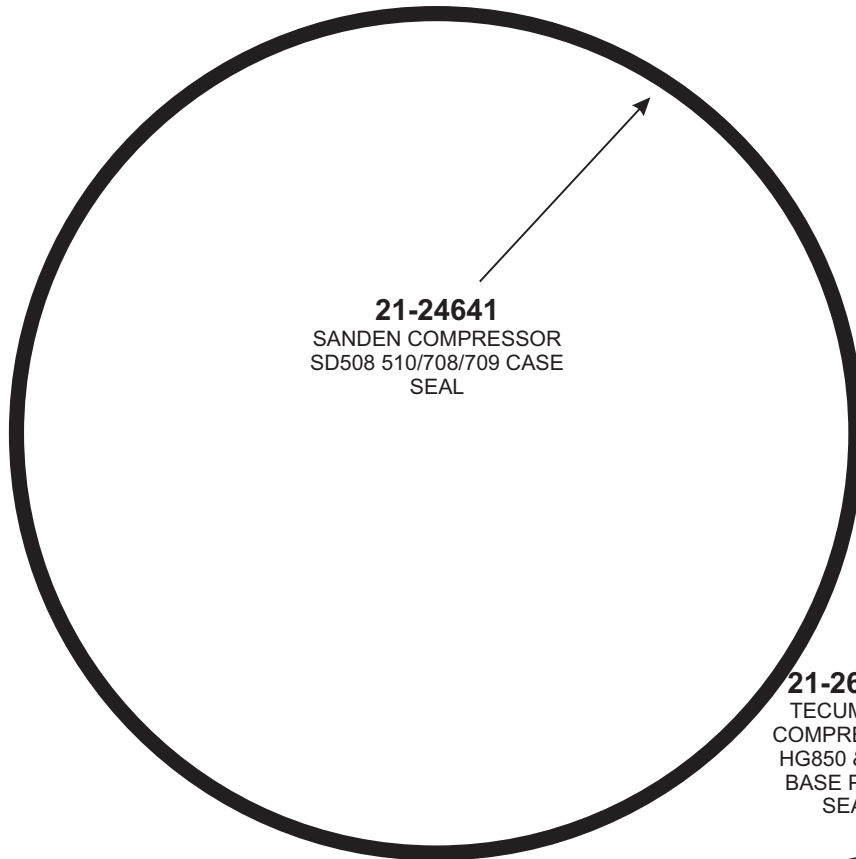

21-24641
SANDEN COMPRESSOR
SD508 510/708/709 CASE
SEAL

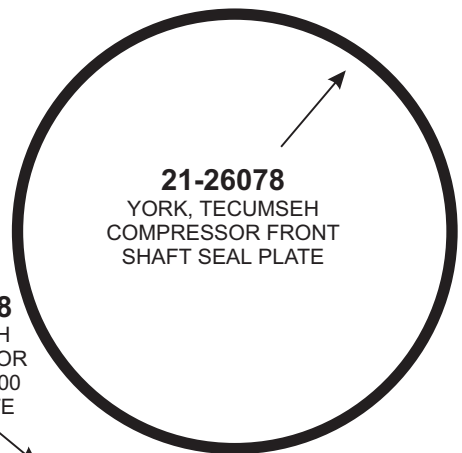

21-26078
YORK, TECUMSEH
COMPRESSOR FRONT
SHAFT SEAL PLATE

21-26068
TECUMSEH
COMPRESSOR
HG850 & 1000
BASE PLATE
SEAL



21-26072
YORK COMPRESSOR FIVE
BOLT SEAL PLATE SEAL

21-26070
MINI TECUMSEH
COMPRESSOR
HG500 BASE
PLATE SEAL

21-26069
TECUMSEH
COMPRESSOR
HG850 / 1000
REAR PLATE
SEAL

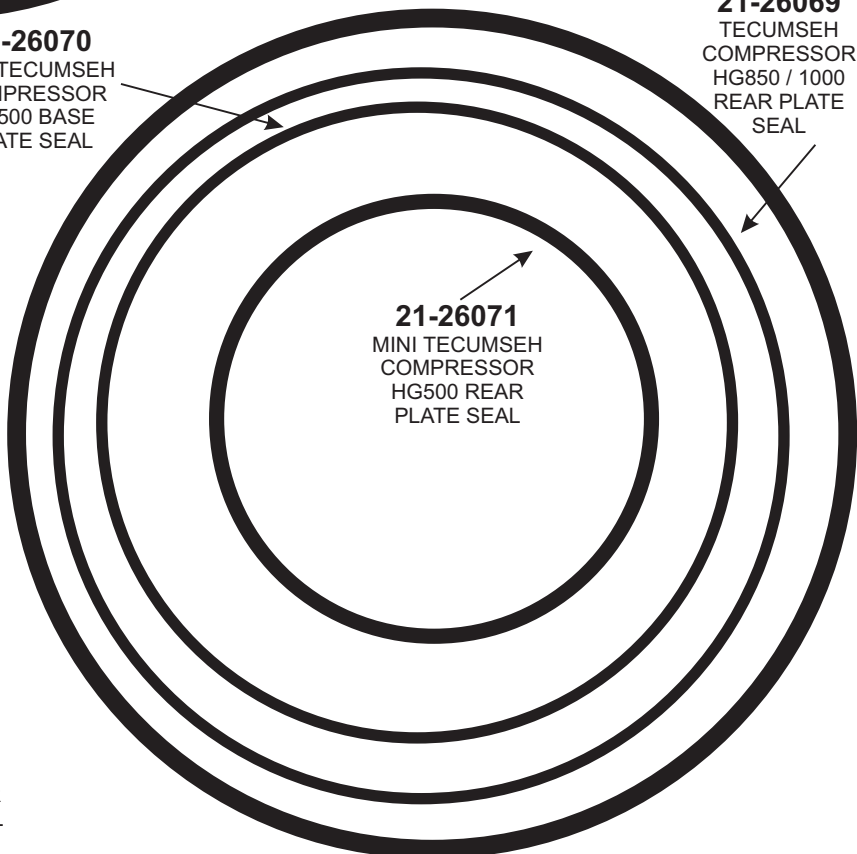

21-26071
MINI TECUMSEH
COMPRESSOR
HG500 REAR
PLATE SEAL

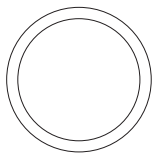

21-26051
YORK, TECUMSEH
COMPRESSOR
ROTOLOCK TEFLON SEAL

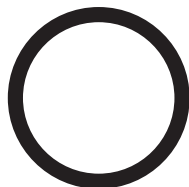

21-26067
YORK COMPRESSOR
SERVICE VALVE SEAL

O-RINGS & GASKETS

IMPORTS

FIBER GASKETS



21-26001
YORK, TECUMSEH
FLANGE SERVICE VALVE
GASKET

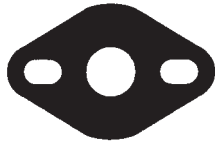

21-26004
YORK, TECUMSEH & RV2
UNIVERSAL FLANGE
SERVICE VALVE GASKET

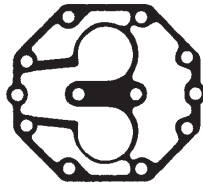

21-26005
YORK HEAD GASKET -
EARLY MODEL

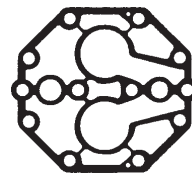

21-26006
YORK HEAD GASKET LATE
MODEL 1968 & UP

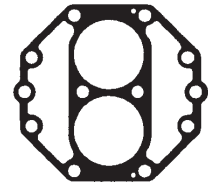

21-26007
YORK VALVE PLATE
GASKET

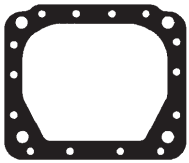

21-26008
YORK BASE PLATE
GASKET

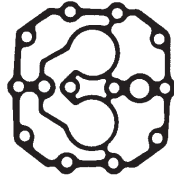

21-26009
TECUMSEH HEAD
GASKET

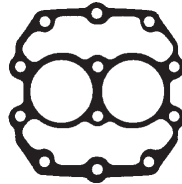

21-26010
TECUMSEH VALVE PLATE
GASKET



21-26014
TECUMSEH MINI HG500
HEAD GASKET

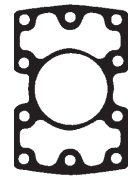

21-26015
TECUMSEH MINI HG500
VALVE PLATE GASKET

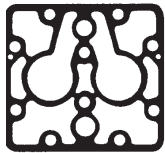

21-26016
YORK MINI 206 HEAD
GASKET

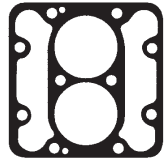

21-26017
YORK MINI 206 VALVE
PLATE GASKET

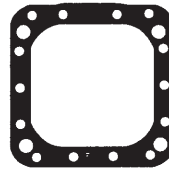

21-26018
YORK MINI 206 BASE
GASKET

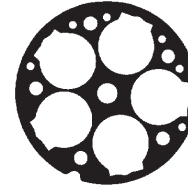

21-26020
SANDEN
SD505/507/508/510
CYLINDER HEAD GASKET

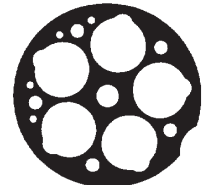

21-26021
SANDEN SD505/507/508/510
CYLINDER HEAD GASKET



21-26022
SANDEN
SD505/507/508/510 VALVE
PLATE GASKET



21-26023
SANDEN
SD505/507/508/510 VALVE
PLATE GASKET

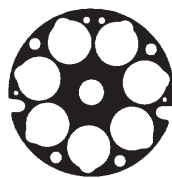

21-26025
SANDEN SD708/709
CYLINDER HEAD GASKET



21-26026
SANDEN SD708/709 VALVE
PLATE GASKET

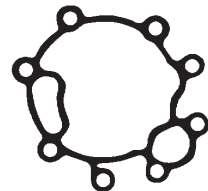

21-26044
YORK VR VANE ROTARY
HEAD GASKET



21-26045
YORK VR VANE ROTARY
CROSSOVER PLATE
GASKET



21-26046
DIESEL KIKI TM15 / DKS15
HEAD GASKET BH MODEL



21-26049
DIESEL KIKI TM15 / DKS15
VALVE PLATE GASKET BH
MODEL



21-26055
YORK & TECUMSEH FRONT
SHAFT SEAL PLATE GASKET
9/32" BOLT

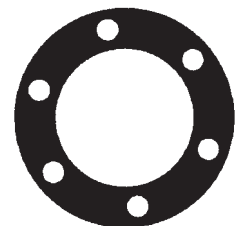

21-26056
YORK & TECUMSEH FRONT
SHAFT SEAL PLATE GASKET
9/32" HOLES

O-RINGS & GASKETS

IMPORTS

FIBER GASKETS



21-26096
DIESEL KIKI CH FRONT
HEAD GASKET



21-26097
DIESEL KIKI CH REAR
HEAD GASKET

METAL GASKETS

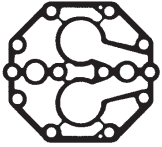

21-84600
YORK FULL SIZE
COMPRESSOR HEAD
GASKET 209 / 210

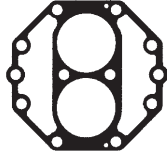

21-84602
YORK FULL SIZE
COMPRESSOR VALVE
PLATE GASKET 209 / 210

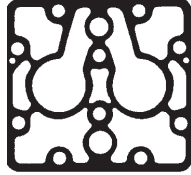

21-84603
YORK MINI SIZE
COMPRESSOR HEAD
GASKET

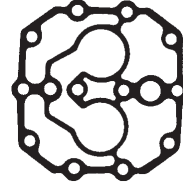

21-84604
TECUMSEH FULL SIZE
COMPRESSOR HEAD
GASKET HG850 / 1000

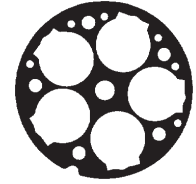

21-84637
SANDEN SD505, 507, 508,
510 HEAD GASKET



21-84638
SANDEN SD505/
507/508/510 VALVE PLATE
GASKET

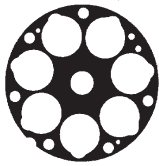

21-84639
SANDEN SD708/709
COMPRESSOR CYLINDER
GASKET













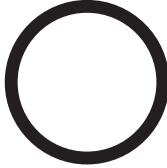



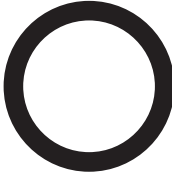

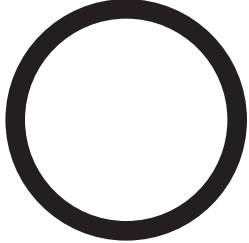
21-84641
SANDEN SD708/709
COMPRESSOR VALVE
PLATE GASKET

ALL FIBER GASKETS ARE
NON-ASBESTOS

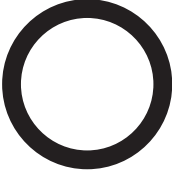
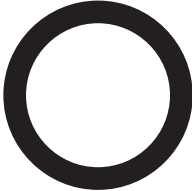
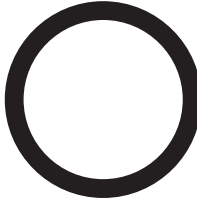
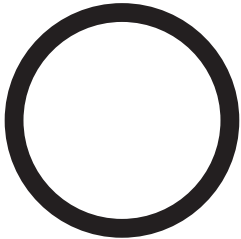
O-RINGS & GASKETS

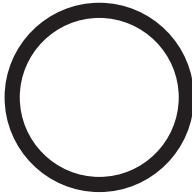
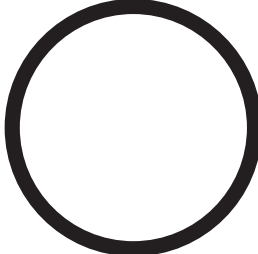
AFTERMARKET

O-RINGS (actual size)				
40-03501 (Green) 	40-03502 (Green) 	40-03503 (Green) 	40-03504 (Green) 	40-02510 
40-02502 #6 HOSE FITTING	40-02503 #8 HOSE FITTING	40-02504 #10 HOSE FITTING	40-02507 #12 HOSE FITTING	Diesel Kiki DKS16CH Oil Plug O-Ring
40-02514 	40-02523 	40-02524 	40-02546 	40-02551 
Sanden Compressor 1/4" Service Port O-Ring	Sanden Comp. Pad Mount Discharge O-Ring	Diesel Kiki BH DKS13G Suction Valve O-Ring	Sanden Comp. TR70 Oil Drain Bolt O-Ring	York YA12, YA15 Comp. Seal Seat O-Ring
40-02554 SEE NEXT PAGE FOR DRAWING	40-02548 SEE NEXT PAGE FOR DRAWING	40-02562 	40-02580 	40-02581 
Diesel Kiki CH Comp. Shell O-Ring Center	Diesel Kiki Comp. BH Shell O-Ring Sanden Compr. TR70 Orbital Rotor O-Ring	Sanden Comp. SD575 Shaft Seal O-Ring	Diesel Kiki DKS-16H Small Oil Plug O-Ring	Diesel Kiki DKS-16 Plug Bolt O-Ring
40-02602 	40-02603 	40-02604 	40-02605 	40-02606 
Diesel Kiki Comp. Through Bolt O-Ring	Diesel Kiki Comp. CH Discharge Port O-ring	Diesel Kiki Comp. Service Valve O-Ring	Diesel Kiki CH Suction Port O-ring	Diesel Kiki Comp. Shaft Seal Seat O-Ring
40-02607 SEE NEXT PAGE FOR DRAWING	40-02609 	40-02610 	40-02611 	40-02612 
Diesel Kiki Compressor CH Front/Rear Shell O-Ring	Sanden Comp. SD575 Shaft Seal O-Ring	Sanden Comp. SD505/507/575 TR70 Shaft Seal Seat O-ring	Sanden SD508/510 Shaft Seal Seat O-ring	Sanden Comp. TR70 Oil Seal Bolt O-Ring

O-RINGS & GASKETS

AFTERMARKET

40-02636

Diesel Kiki Comp.
BH DKS13G Seal
Seat O-Ring

40-02626

Tecumseh Compressor
Gland Plate O-Ring

40-02629

Tecumseh Comp. HG500
Rear Plate O-Ring

40-02548

Sanden Comp. TR70 Scroll
To Rear Housing O-Ring

40-02649

40-02607

40-02554

O-RINGS & GASKETS

AFTERMARKET

Assortment Kits

21-24710 UNIVERSAL O-RING ASSORTMENT KIT
 21-24755 UNIVERSAL COMPRESSOR SERVICE PORT O-RING KIT

Black R12 (only)	Black R12 /R134a	Blue R12 /R134a	Green R12 /R134a	Yellow R12 /R134a
---------------------	---------------------	--------------------	---------------------	----------------------

Lathe Cut Seals

21-24641	21-24641 N	21-24641 B			SANDEN COMP. SD508/510/708/709 CASE SEAL
21-26051					YORK, TECUMSEH COMP. ROTALOCK TEFLON SEAL
21-26059					YORK, TECUMSEH COMP. TUBE-O SERVICE VALVE SEAL
21-26067	21-26067 N				YORK COMP. SERVICE VALVE SEAL
21-26068	21-26068 N	21-26068 B			TECUMSEH COMP. HG850 / 1000 PLATE SEAL
21-26069	21-26069 N	21-26069 B			TECUMSEH COMP. HG850 / 1000 REAR PLATE SEAL
21-26070	21-26070 N	21-26070 B			MINI TECUMSEH COMP. HG500 BASE PLATE SEAL
21-26071	21-26071 N	21-26071 B			MINI TECUMSEH COMP. HG500 REAR PLATE SEAL
21-26072	21-26072 N	21-26072 B			YORK COMPRESSOR FIVE BOLT SEAL PLATE SEAL
21-26078	21-26078 N	21-26078 B			YORK, TECUMSEH COMP. FRONT SHAFT SEAL PLATE

Fiber Gaskets

21-26001	YORK, TECUMSEH FLANGE SERVICE VALVE GASKET
21-26004	YORK, TECUMSEH UNIVERSAL FLANGE GASKET
21-26005	YORK HEAD GASKET EARLY MODEL
21-26006	YORK HEAD GASKET LATE MODEL
21-26007	YORK VALVE PLATE GASKET
21-26008	YORK BASE PLATE GASKET
21-26009	TECUMSEH HEAD GASKET
21-26010	TECUMSEH VALVE PLATE GASKET
21-26014	TECUMSEH MINI HG500 HEAD GASKET
21-26015	TECUMSEH MINI HG500 VALVE PLATE GASKET
21-26016	YORK MINI 206 HEAD GASKET
21-26017	YORK MINI 206 VALVE PLATE GASKET
21-26018	YORK MINI 206 BASE GASKET
21-26020	SANDEN CYLINDER HEAD GASKET
21-26021	SANDEN CYLINDER HEAD GASKET
21-26022	SANDEN VALVE PLATE GASKET
21-26023	SANDEN VALVE PLATE GASKET
21-26025	SANDEN CYLINDER HEAD GASKET
21-26026	SANDEN VALVE PLATE GASKET
21-26044	YORK VR VANE ROTARY HEAD GASKET
21-26045	YORK VR VANE ROTARY CROSSOVER PLATE
21-26046	DIESEL KIKI TM15 HEAD GASKET
21-26049	DIESEL KIKI TM15 VALVE PLATE GASKET
21-26055	YORK & TECUMSEH FRONT SHAFT SEAL PLATE GASKET
21-26056	YORK & TECUMSEH FRONT SHAFT SEAL PLATE GASKET
21-26096	DIESEL KIKI CH FRONT HEAD GASKET
21-26097	DIESEL KIKI CH REAR HEAD GASKET

Metal Gaskets

21-84600	YORK FULL SIZE COMPRESSOR HEAD GASKET
21-84602	YORK FULL SIZE COMPRESSOR VALVE PLATE GASKET
21-84603	YORK MINI SIZE COMPRESSOR HEAD GASKET
21-84604	TECUMSEH FULL SIZE COMPRESSOR HEAD GASKET
21-84637	SANDEN HEAD GASKET
21-84638	SANDEN VALVE PLATE GASKET
21-84639	SANDEN COMPRESSOR CYLINDER GASKET
21-84641	SANDEN VALVE PLATE GASKET

Black R12 (only)	Black R12 /R134a	Blue R12 /R134a	Green R12 /R134a	Yellow R12 /R134a
---------------------	---------------------	--------------------	---------------------	----------------------

O-Rings

40-02502	40-02502 N	40-02502 B	40-03501	40-02502 Y	#6 Hose Fitting O-Ring
40-02503	40-02503 N	40-02503 B	40-03502	40-02503 Y	#8 Hose Fitting O-Ring
40-02504	40-02504 N	40-02504 B	40-03503	40-02504 Y	#10 Hose Fitting O-Ring
40-02507	40-02507 N	40-02507 B	40-03504	40-02507 Y	#12 Hose Fitting O-Ring
40-02510	40-02510 N	40-02510 B	40-02510 G		Oil Tube O-Ring
40-02514	40-02514 N	40-02514 B	40-02514 G		Standard Cycling Switch O-Ring
40-02523	40-02523 N	40-02523 B	40-02523 G		Sanden Pad Mount Discharge O-Ring
40-02524	40-02524 N	40-02524 B	40-02524 G		GM V5 Control Valve O-Ring
40-02546	40-02546 N	40-02546 B	40-02546 G		Sanden TR70 Oil Drain Bolt O-Ring

O-RINGS & GASKETS

AFTERMARKET

Black R12 (only)	Black R12 /R134a	Blue R12 /R134a	Green R12 /R134a	Yellow R12 /R134a	
40-02548	40-02548 N	40-02548 B	40-02548 G		Diesel Kiki O-Ring
40-02551	40-02551 N	40-02551 B	40-02551 G		GM Heat Switch O-Ring
40-02554	40-02554 N	40-02554 B	40-02554 G		GM V5 Shell O-Ring
40-02562	40-02562 N	40-02562 B	40-02562 G		Saturn Metric O-Ring
40-02580	40-02580 N	40-02580 B	40-02580 G		Diesel Kiki DKS16H Small Oil Plug O-Ring
40-02581	40-02581 N	40-02581 B	40-02581 G		Diesel Kiki DKS16 Plug Bolt O-Ring
40-02602	40-02602 N	40-02602 B	40-02602 G		Diesel Kiki Comp. O-Ring
40-02603	40-02603 N	40-02603 B	40-02603 G		Diesel Kiki Comp CH Discharge O-Ring
40-02604	40-02604 N	40-02604 B	40-02604 G		Diesel Kiki Comp Service Valve O-Ring
40-02605	40-02605 N	40-02605 B	40-02605 G		Diesel Kiki CH Suction Port O-Ring
40-02606	40-02606 N	40-02606 B	40-02606 G		Diesel Kiki Shaft Seal O-Ring
40-02607	40-02607 N	40-02607 B	40-02607 G		Diesel Kiki Comp. CH Front / Rear O-Ring
40-02609	40-02609 N	40-02609 B	40-02609 G		Sanden Comp. SD575 Shaft Seal O-Ring
40-02610	40-02610 N	40-02610 B	40-02610 G		Sanden Seal Seat O-Ring
40-02611	40-02611 N	40-02611 B	40-02611 G		Sanden Shaft Seal O-Ring
40-02612	40-02612 N	40-02612 B	40-02612 G		Sanden Comp. TR70 Oil Seal O-Ring
40-02626	40-02626 N	40-02626 B	40-02626 G		Tecumseh Comp Valve Plate O-Ring
40-02629	40-02629 N	40-02629 B	40-02629 G		Tecumseh HG500 Rear Plate O-Ring
40-02636	40-02636 N	40-02636 B	40-02636 G		Diesel Kiki Comp BH Seal Seat O-Ring
40-02649	40-02649 N	40-02649 B	40-02649 G		Sanden Comp TR70 Scroll Housing O-Ring1